

ChowBELL2 PRO



User Manual for video doorbell



Index

Introduction of the ChowBELL2 Pro	P2
Product Overview	P2
Kit contents	P3
Specifications	P3
Hardware installation_Wi-fi	P4
Hardware installation_LAN cable	P5
Pairing indoor chime with ChowBELL2 Pro	P6
Apply for a new Chow account	P7
Connect ChowBELL2 Pro to Chow! App	P8
Owner shares the ChowBELL2 Pro to other users	P10
Connect your ChowBELL2 Pro with a gate opener	P12
Add RFID cards to trigger the NC/COM/NO output terminal on ChowBELL2 Pro	P13
FAQ	P16



Introduction of the ChowBELL2 Pro

This user manual is designed to provide indications of the ChowBELL2 Pro and its features and functions.

ChowBELL2 Pro is a device which can connect to App! and provide two-way audio communication.

ChowBELL2 Pro can be intergrated with other Wi-Fi gate openers on the Chow! App.

Product Overview

Video Doorbell

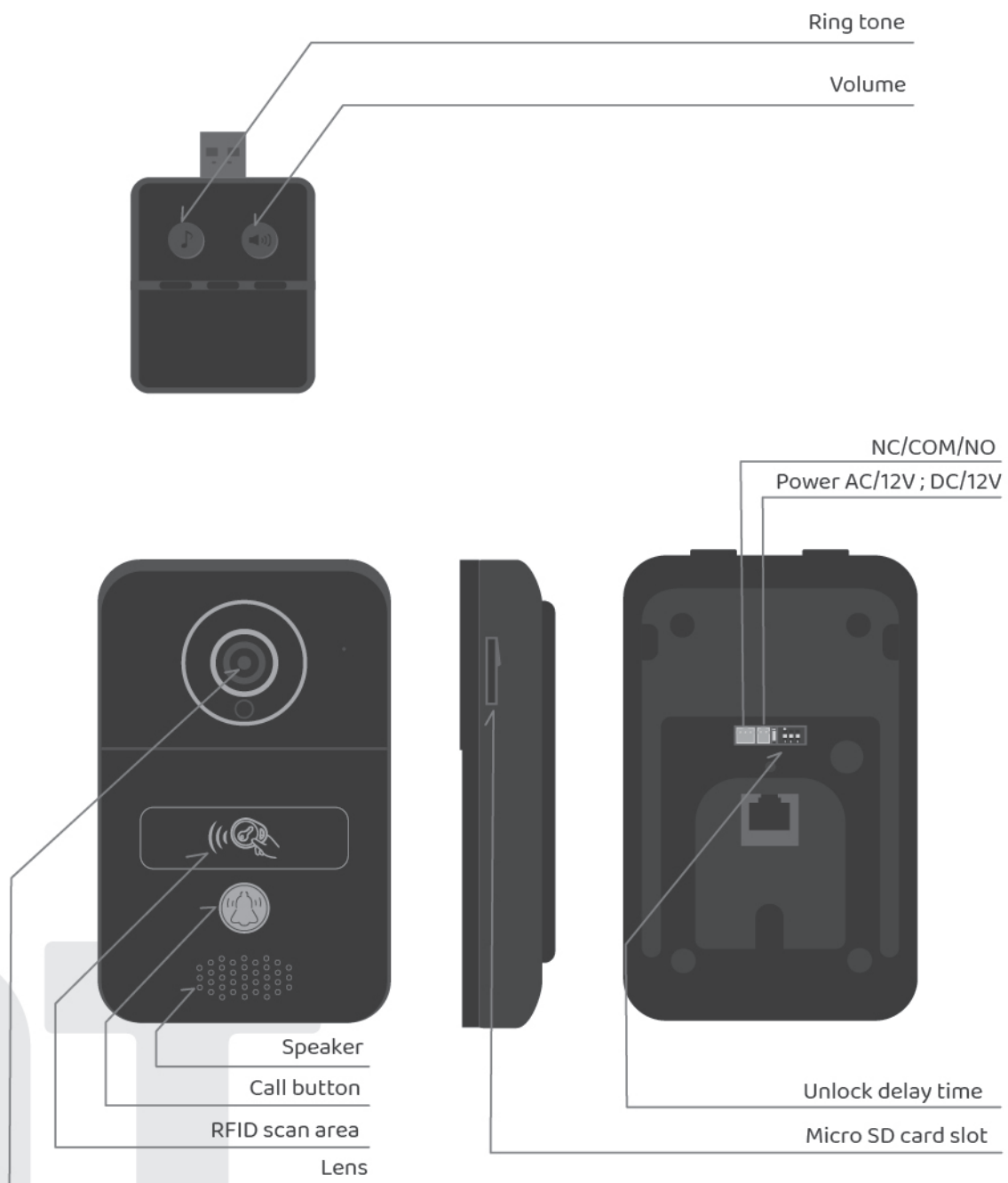

Kit contents

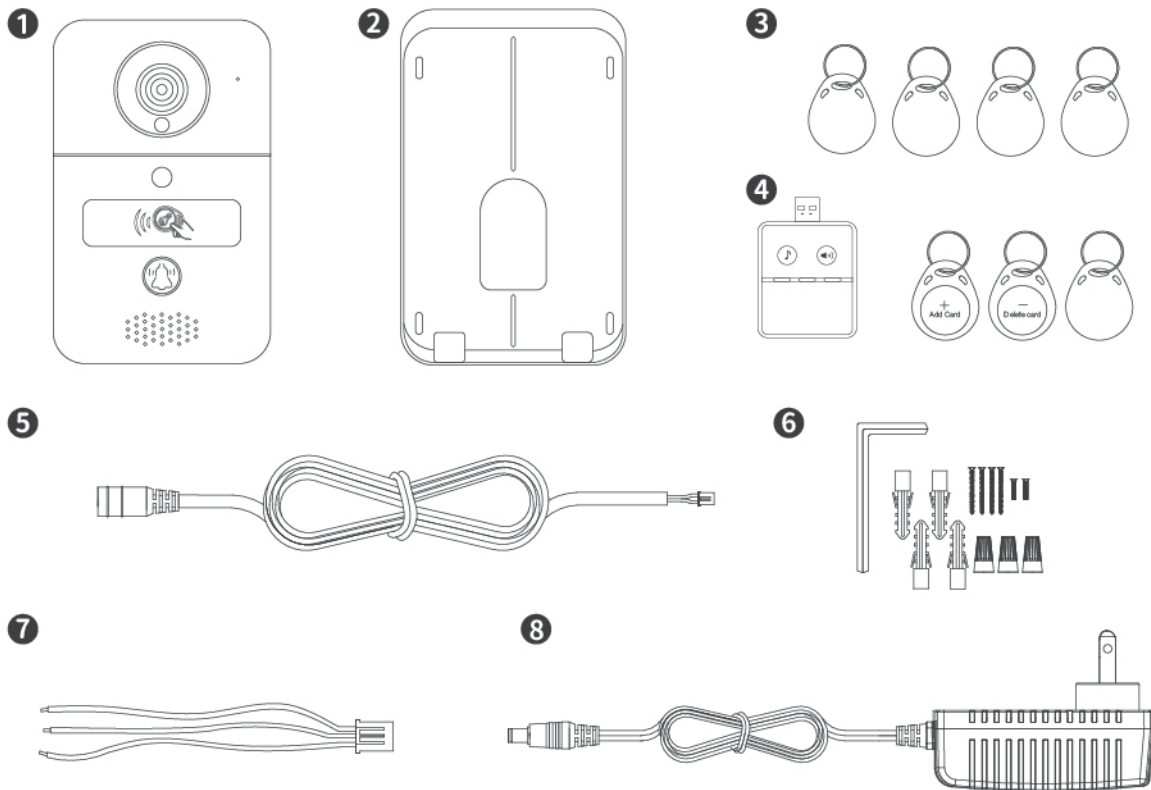

- 1** ChowBELL2 Pro **2** Wall mount bracket **3** RFID cards **4** Indoor chime
- 6** Parts package **7** Power wire **8** 12V Power **5** DC cable

Specifications

Image Sensor	Display Resolution	1920 x 1080
	Viewing Angle	140°
Video	Image Compression	H.264
	Image Frame Rate	25 fps
	Record Mode	Motion detection
Audio	Audio	Two-way Audio
Communication	Wireless Standard	IEEE 802.11b/g/n
	Wire	10/100Mbps
	Infrared Light	Built-in IR LED, Night visibility up to 5 meters
	SD Card	256GB MAX
	Motion Detection	Support
Power	Power Supply	DC 12V ; 48V POE
Security	Alarm	Push notification

Hardware installation -connect to Wi-Fi

Connect to your home Wi-Fi

1. Connect the ChowBELL2 Pro via 2.4GHz Wi-Fi. Please make sure your Wi-Fi signal is strong and stable.

Hardware installation

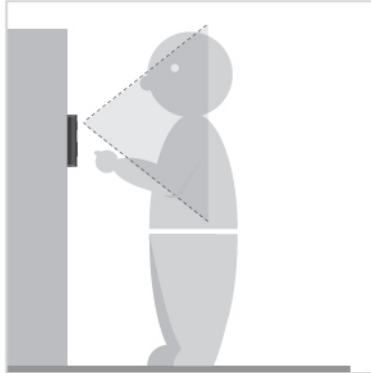

- 1 Choose a proper location for the Chow BELL2 Pro, be sure to consider the average height of visitors.

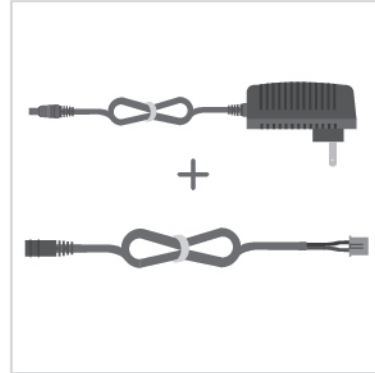

- 2 Connect the 12V power plug to the DC cable.

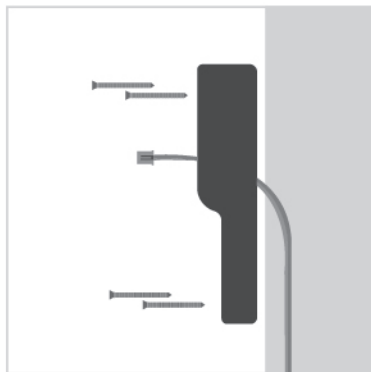

- 3 Align the DC cable and wall mount bracket with the hole on wall; fasten the wall mount bracket.



- 4 Connect the DC cable to the ChowBELL2 Pro 12V terminal



- 5 Fasten the ChowBELL2 Pro on the wall mount bracket with an allen key and a screw from parts package.



- 6 Refer to page 10 connect ChowBELL2 Pro to Eyeopen App to finish the Wi-Fi connection.

Hardware installation - connect to LAN cable

Connect to LAN cable

1. Please connect your ChowBELL2 Pro to the Wi-Fi network before connect to the LAN cable.
2. ChowBELL2 Pro has a RJ45 port which is used for connecting to the router with a LAN cable.

Hardware installation

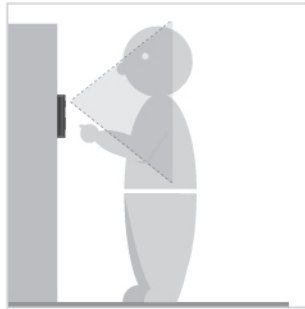

- 1 Choose a proper location for the ChowBELL2 Pro, be sure to consider the average height of visitors.

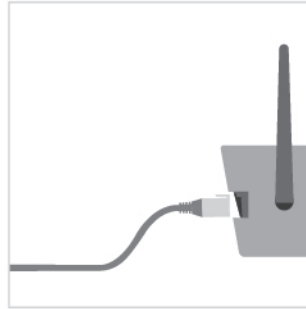

- 2 Connect the POE wire to your router.

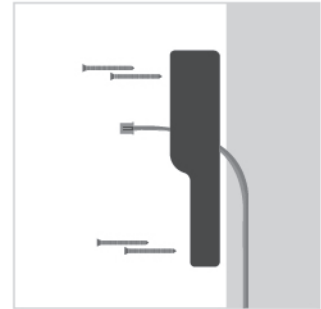

- 3 Align the LAN cable and wall mount bracket with the hole on wall; fasten the wall mount bracket.

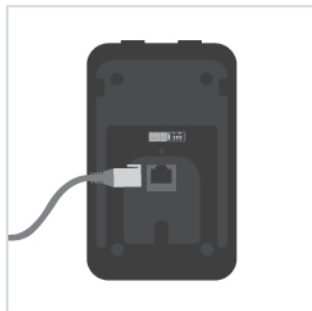

- 4 Connect the LAN cable (cable not supported) to the back of the ChowBELL2 Pro.



- 5 Fasten the ChowBELL2 Pro on the wall mount bracket with an allen key and a screw from parts package.



- 6 Refer to page 7 Connect ChowBELL2 Pro to Eyeopen App to finish the Wi-Fi connection.

★ ***Please make sure the Wi-Fi you connected and the LAN cable are going to connect is shared the same SSID***



Pairing indoor chime with ChowBELL2 Pro

Connect the indoor chime to the power via the USB port / USB adaptor, please also ensure ChowBELL2 Pro is powered.

Step1 Press and hold the  indoor chime rings for 2 seconds.

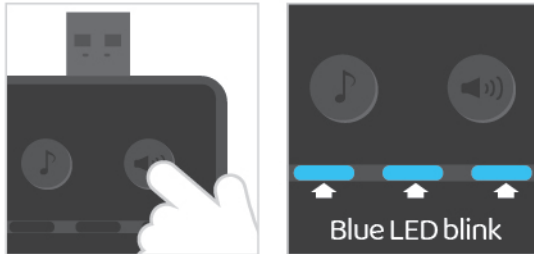

Step2 Press the  indoor LED blinks once and chime rings once.

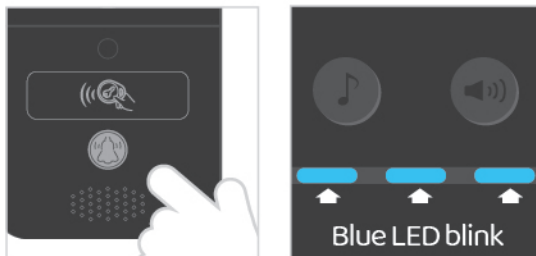

Step3 Press the  indoor LED blinks 5 times and the pairing is done

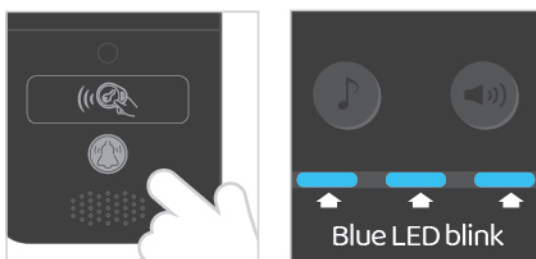

NOTE

Operation - Press the  and the indoor chime rings and LED blinks at the same time.

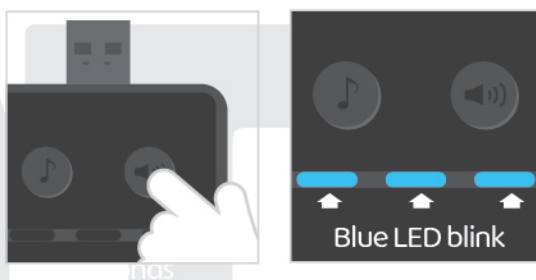

Apply for a new Chow account

1. Please scan the QR code and download the Chow! App
2. Press Sign Up icon and press the agree icon to continue
3. Please type the following information for registration :
 - a. Account (a-z, A-Z, 0-9 only)
 - b. Email (enter twice for verification)
 - c. Password (enter twice for verification)
 - d. The password should have at least 1 English character and at least 8 characters in total
4. The system will send a link to your email when the registration succeeds
5. Please go to your email ,and click the link to activate your Chow account
6. Log in to your personal TMT Chow account by key in the Account name and Password when Sing Up

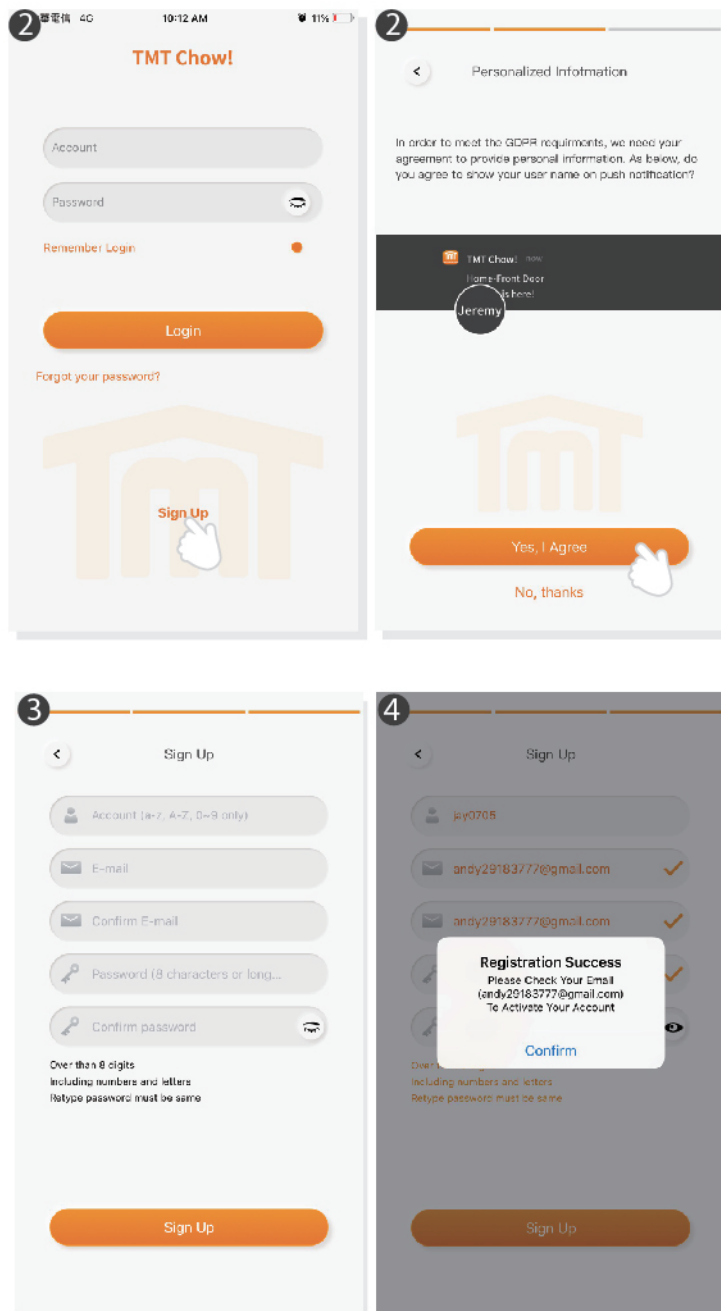

Connect ChowBELL2 Pro to Chow! App

Step1 add a new ChowBELL2 Pro

Tap the (+) icon to add a new device
New device -> Accessories -> ChowBELL Pro

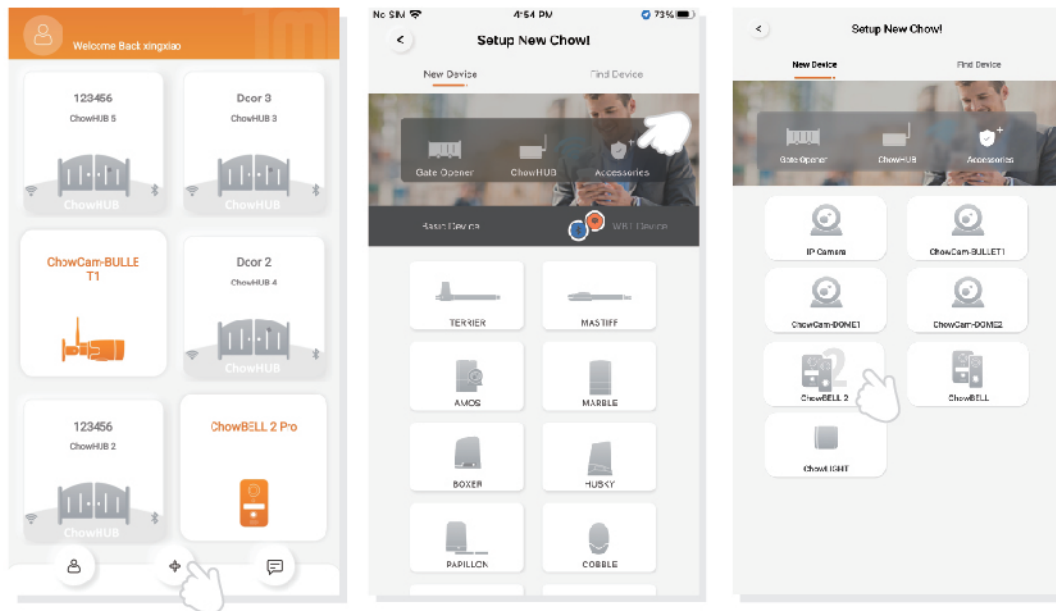

Tap the (Scan QR code) icon
Follow the indications as below:

Step 1 - Power the device

Step 2 - Reset the device

Step 3 - ChowBELL2 Pro sound once when it has been reset

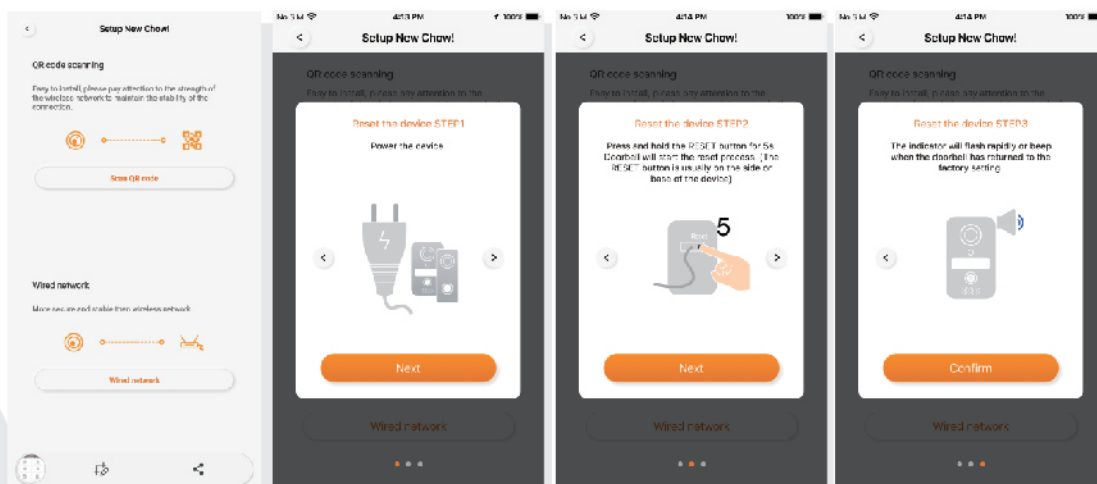

Step 2 Connect ChowBELL2 Pro

Entering the correct password for the Wi-Fi network and press set
 Scan the QR code in front of the camera until it sounds once
 The system starts connecting to Wi-Fi network.

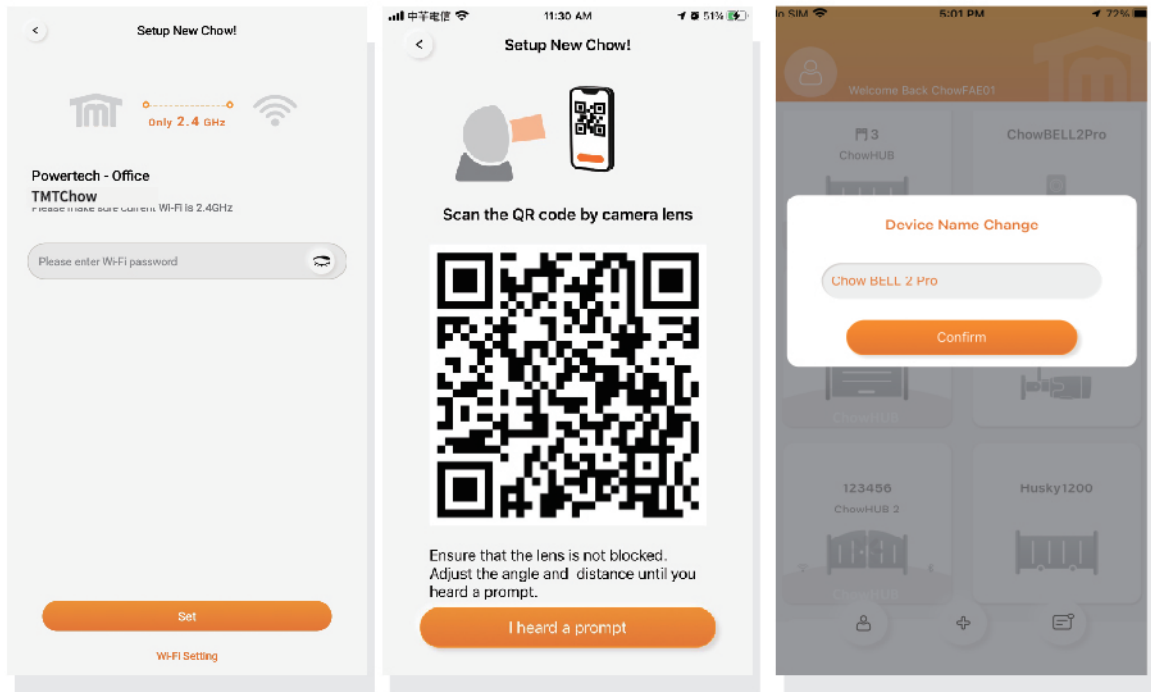

Step 3 Setting

Tap the icon of the ChowBELL2 Pro to enter the operation page.

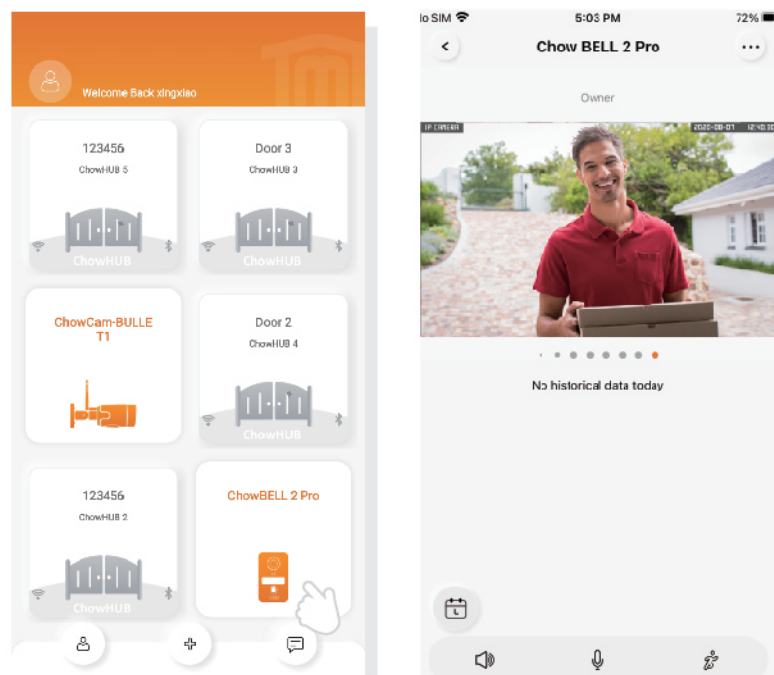

Owner shares the ChowBELL2 Pro to other users

- 1 The device owner can share the ChowBELL2 Pro up to 4 users through Chow! APP
Tap the icon to enter the account manage page
- 2 Tap the Mange shared device icon
- 3 Enter the account name to share with
(People need to be shared require Sing Up their personal account)
- 4 Select the device which you like to share with

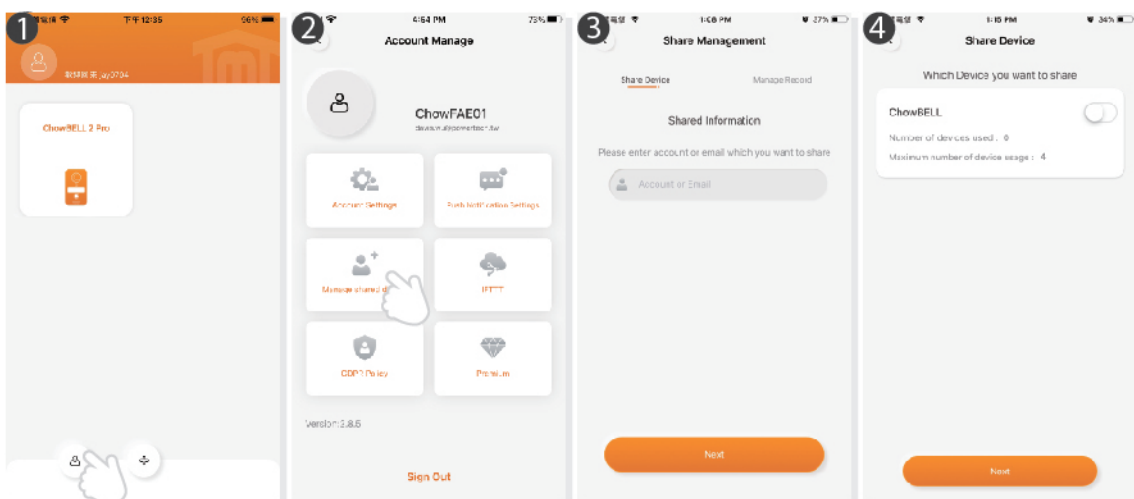

Make a successful ChowBELL2 Pro setup with your home Wi-Fi

Suggest to bring the ChowBELL2 Pro device close to the home Wi-Fi router as near as possible to receive the best Wi-Fi signal. And make sure the home Wi-Fi source is 2.4G from the router not 5G, also must enter the correct pass word for the home Wi-Fi to complete the setup.

After the ChowBELL2 Pro has been successfully connected to your home Wi-Fi, you may combine the image output with your automation system to start operating.

Operation page of ChowBELL2 Pro

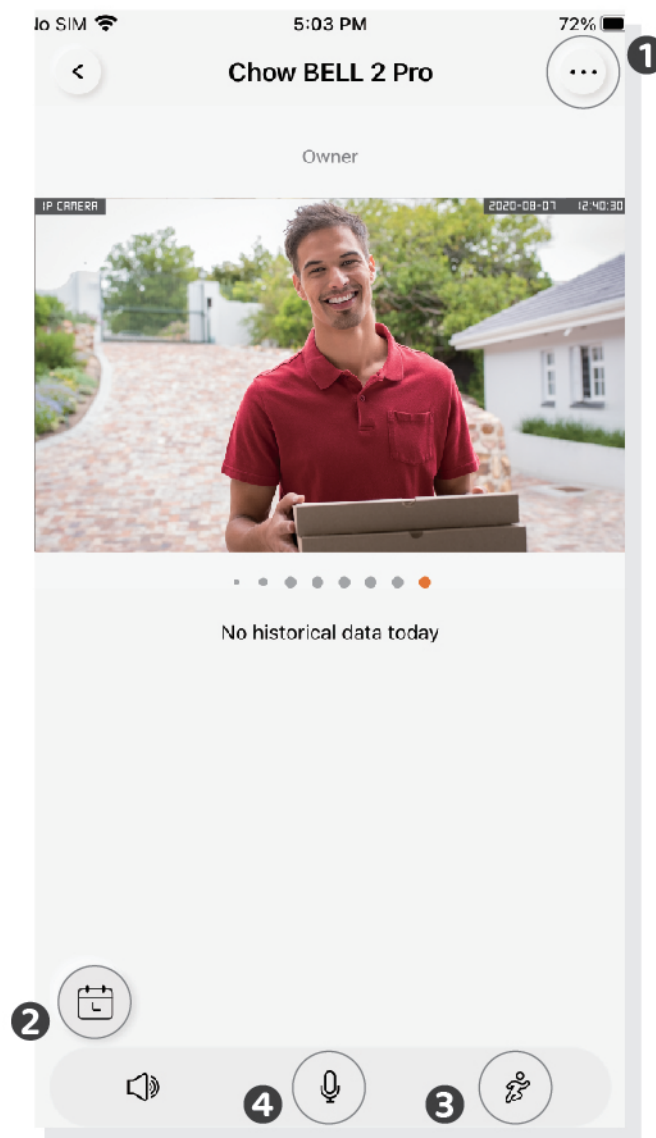

- 1 Setting
- 2 With an extra micro SD card, the recorded videos will be listed in the calendar
- 3 Switch of the Motion detection. You will get notifications when you turn it ON.
- 4 Switch of the two-way audio. Turn ON to start the audio function

Connect your ChowBELL2 Pro with a gate opener

To connect your ChowBELL2 Pro to the gate opener, please go the operation page of a gate opener.

- 1 Gate opener operation page
- 2 Settings
- 3 Available Accessories
- 4 Select ChowBELL2 Pro from the list.

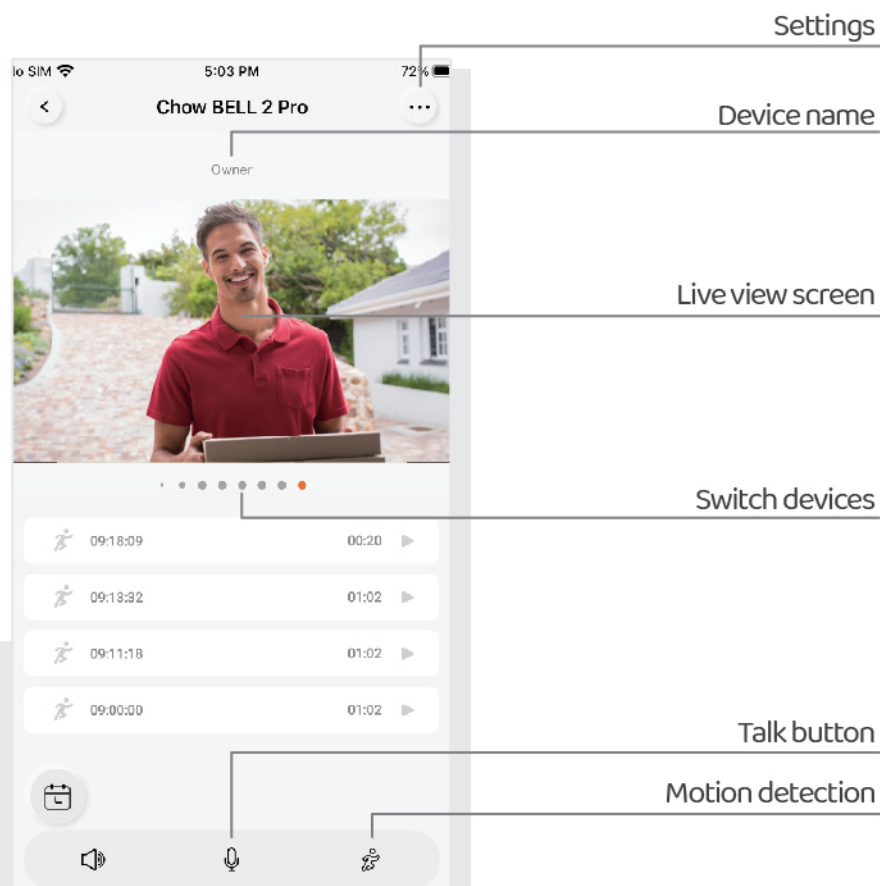
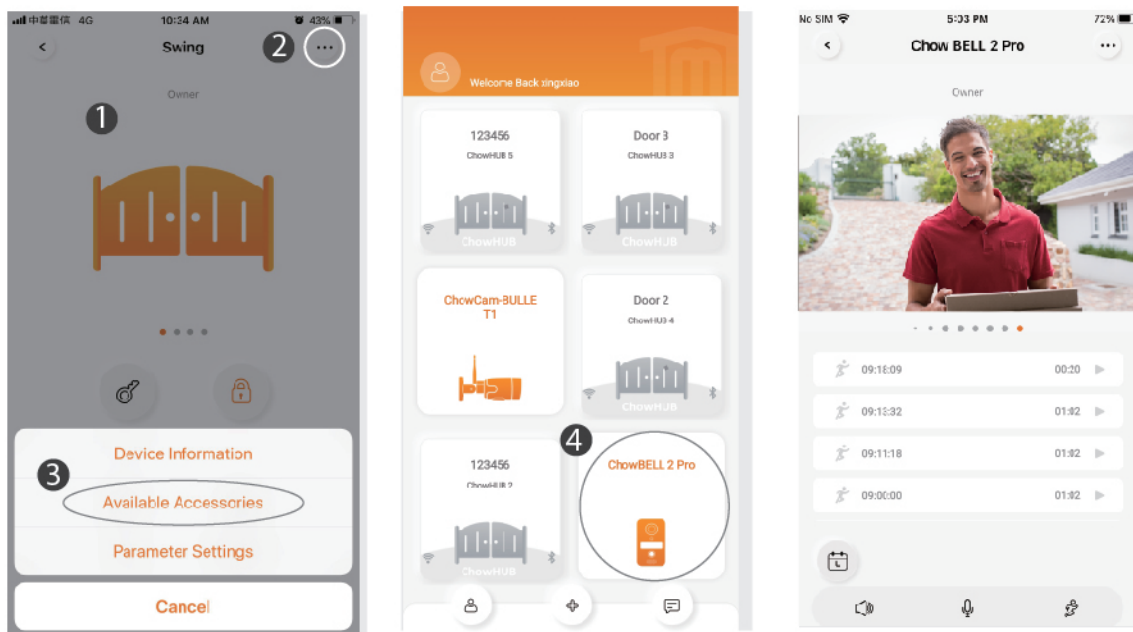

Add RFID cards to trigger the NC/COM/NO output terminal on ChowBELL2 Pro (like electric latch control)

Terminals of the ChowBELL2 Pro

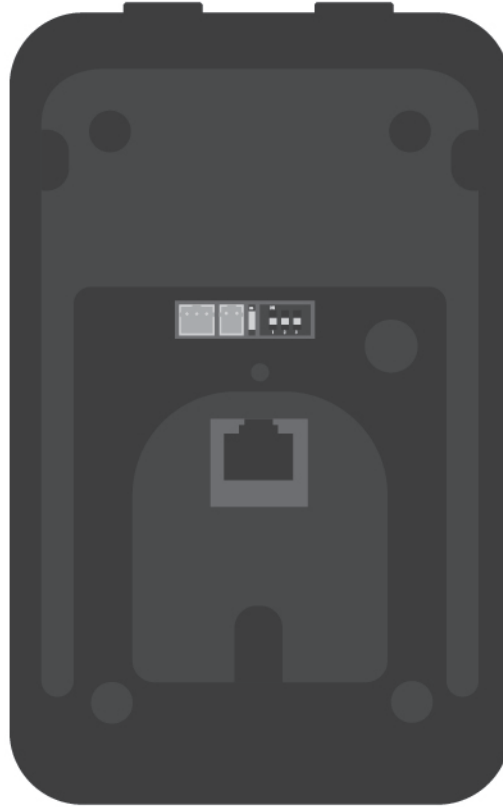

Function of each terminal

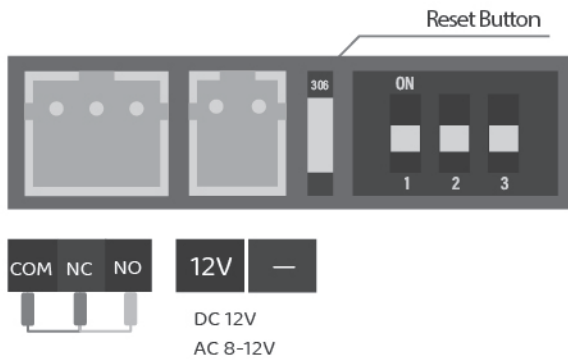

This terminal can be triggered by Blue(User) RFID cards and the Ext icon on the operation page



Triggered by the Ext icon on the operation page

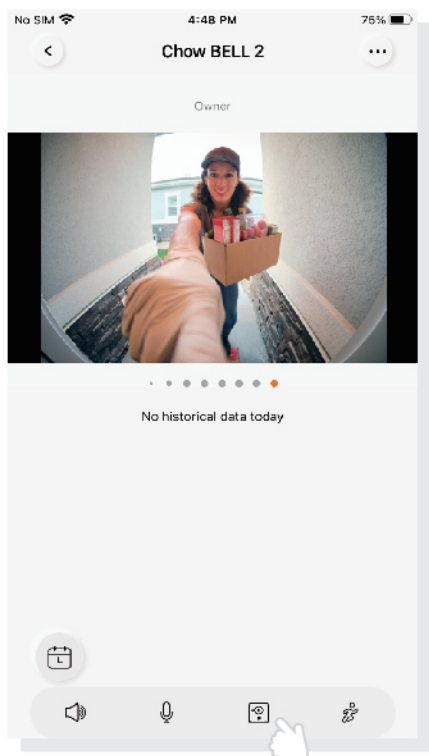

Set the Ext icon

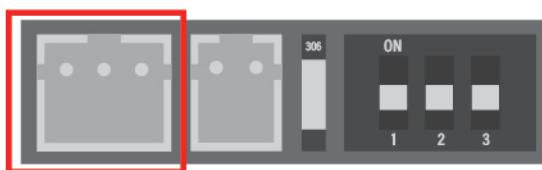

The relay works once when press the icon

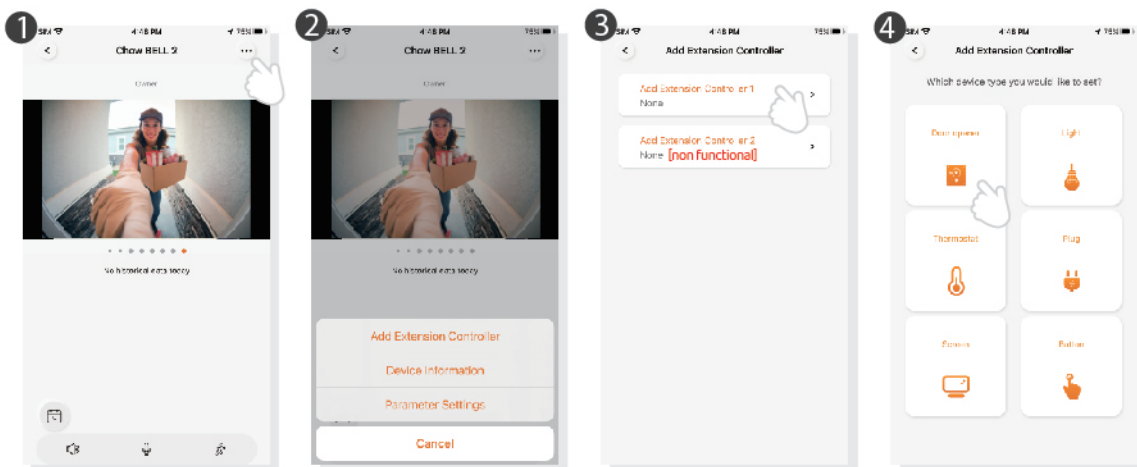

1. Tap the (...) icon on the operation page
2. Tap the Add Extension Controller
3. Tap the controller 1 icon
4. Choose the door opener

Triggered by RFID cards

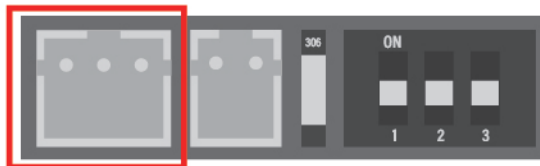

The relay works once the ChowBELL is triggered by a RFID card

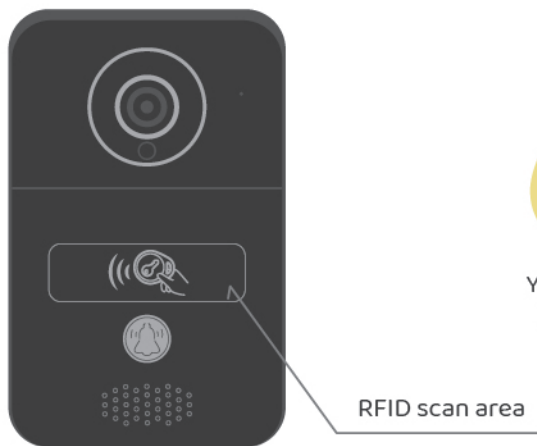

Yellow(Add) RFID card



Red(Delete) RFID card



Blue(User) RFID card

Add RFID cards

1. Please scan the YELLOW (Add) RFID card.
The scan area shows BLUE light ON with a beep which activates the system for adding the BLUE (User) RFID card.
2. Scan a BLUE (User) RFID card and the BLUE LED shows ON with a beep which indicates adding user card successfully.
3. Scan the YELLOW (Add) RFID card AGAIN and the BLUE light goes OFF which deactivates the pairing mode.

After scanning the yellow (Add) RFID card, the system shows red light with 3 beeps which indicates activation fail. Please scan the yellow RFID card again.

Delete RFID cards

1. Please scan the RED(Delete) RFID card.
The scan area shows RED light ON with a beep which activates the system for deleting the BLUE (User) RFID card.
2. Scan a PAIRED BLUE (User) RFID card and the RED LED shows ON with a beep which indicates deleting user card successfully.
3. Scan the RED (Delete) RFID card AGAIN and the RED light goes OFF which deactivates the delete mode.

After scanning the red (Delete) RFID card, the system shows red light with 3 beeps which indicates activation fail. Please scan the red (Delete) RFID card again.

FAQ

Question 1

How to Reset ChowBELL2 Pro to default setting?

Answer 1

1. Delete the ChowBELL2 Pro on the Chow! App by long pressing the ChowBELL2 Pro icon and confirm it.
 2. Press Reset button at the back of the ChowBELL2 Pro for 5 seconds to reset ChowBELL Pro to default setting.
 3. Please refer to Page7 Connect ChowBELL2 Pro to Chow! App to reconnect the ChowBELL Pro.
-

Question 2

Unable to receive notification from my ChowBELL2 Pro

Answer 2

Go the setting page of the Chow! App

Turn on the switch of notification to receive the notifications

not

TOT AUTOMATION INC

