

b&d

PanelMax™

Sectional Door Opener

installation instructions

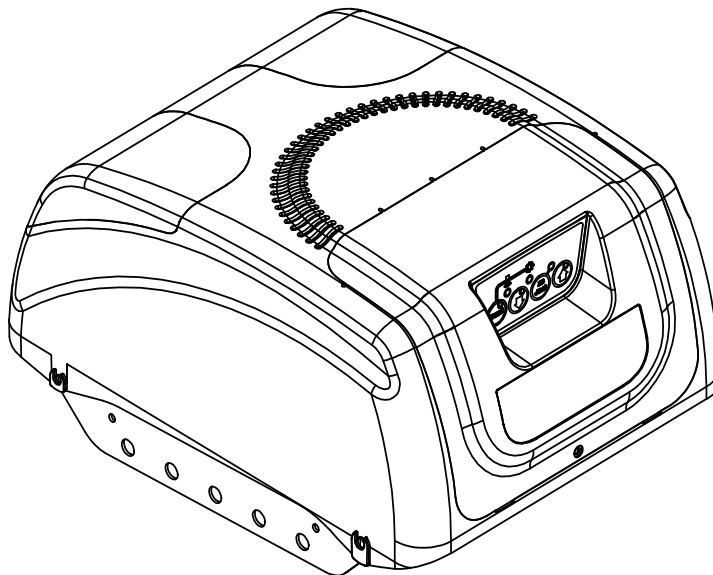

PanelMax™ SDO-8V3

These instructions are intended for professional garage door opener installers.

All references are taken from inside looking out.

DOC# 161060_04
RELEASED: 11/10/22

www.bnd.com.au

b&d

Contents

Important Safety Warnings

1. Safety Warnings!	3
---------------------	---

Installation Instructions

2. Before you Begin	5
3. Tools Required	5
4. Kit Contents	6
5. Position	6
6. Fit the Opener	7
7. Bracket Position	7
8. Perforated Angle	8
9. Mounting Brackets and Arms	8
10. Optional Safety Beam Kit	9
10.1 Inserting batteries into receiver and transmitter	9
10.2 Assemble the Mounting Bracket	9
10.3 Mounting the Bracket	9
10.4 Aligning the Transmitter and Receiver	9
11. Specifications	10
12. Setting Limits	11
12.1 Set the Limit Positions and adjust drive speed:	11
12.2 Clearing the Door Limit Positions	12
12.3 Re-profiling the Door	12
12.4 Controller memory reset	12
13. Safety Testing	13
13.1 Test the Close Cycle	13
13.2 Testing the Open Cycle	13
13.3 Test the Manual Door Operation	13
14. Auto-Close	14
14.1 Auto-Close	14
14.2 Terminal Block	15
14.3 Connecting or Disconnecting Accessories	15

15. Coding a Transmitter	16
15.1 Storing the Transmitter Code	16
15.2 Remotely Coding Transmitters	16
15.3 Erasing All Transmitter Codes	17
15.4 Vacation Mode	17
15.5 Installing the Wall Mounted Transmitter	17

Home Owner Instructions

16. Opener Safety & Security	18
16.1 Your Door CAN NOT be used by the opener when:	18
16.2 Your Door CAN be used when:	18
16.3 To Disengage the Opener:	18
16.4 To Re-engage the Opener:	18
17. Operating your Opener	18
18. User Operating Controls	19
19. Troubleshooting	20
20. After Installation Care	22
20.1 Service Checklist	22
20.2 Battery Replacement	23
20.3 Battery Disposal	23
20.4 Warranty	23
21. Appendix	24
A - Status Indication during Operating Mode.	24
B - Adjustment Mode Instructions	25
C - Adjusting Force Margins	26
D - Battery Functions	26
E - Setting the PET mode position	26
F - Setting Limits via Transmitter	27
G - Setting up Tilt Door	28

WARNING! IMPORTANT SAFETY INSTRUCTIONS

FOLLOW ALL INSTRUCTIONS SINCE INCORRECT INSTALLATION CAN LEAD TO SEVERE INJURY.

- before installing the drive, remove all unnecessary ropes or chains and disable any equipment, such as locks, not needed for powered operation;
- before installing the drive, check that the door is in good mechanical condition, correctly balanced and opens and closes properly;
- install the actuating member for the manual release at a height less than 1,8 m;
- install any fixed control at a height of at least 1,5 m and within sight of the door but away from moving parts;
- permanently fix the labels warning against entrapment in a prominent place or near any fixed controls;
- permanently fix the label concerning the manual release adjacent to its actuating member;
- after installation, ensure that the mechanism is properly adjusted and that the drive reverses when the door contacts a 40 mm high object placed on the floor.
- necessary information for the safe handling of a drive weighing more than 20 kg. This information shall describe how to use the handling means, such as hooks and ropes;
- the drive must not be used with a door incorporating a wicket door (unless the drive cannot be operated with the wicket door open);
- after installation, ensure that parts of the door do not extend over public footpaths or roads.
- vertical doors and gates need an anti-drop feature or device;
- information if a hazardous part of the drive is intended to be installed at a height of at least 2.5 m above floor level or other access level;
- except for horizontally moving pedestrian doors, ensure that entrapment due to the opening movement of the driven part is avoided

1. Safety Warnings! (for installation)

This automatic garage door opener is designed and tested to offer safe service provided it is installed and operated in strict accordance with the following safety warnings. Failure to comply with the following instructions may result in death, serious personal injury or property damage.



WARNING!

- The door may operate unexpectedly, therefore do not allow anything to stay in the path of the door.
- When operating the manual release while the door is open, the door may fall rapidly due to weak or broken springs, or due to being improperly balanced.
- The drive must not be used with a door incorporating a wicket door, unless the drive cannot be operated with the wicket door open.
- The drive is intended to be installed at least 2.5m above the floor.
- Do not disengage the opener to manual operation with children/persons or any objects including motor vehicles within the doorway.
- If the door is closing and is unable to re-open when obstructed, discontinue use. Do not use a door with faulty obstruction sensing
- When using auto close mode, a Photo Electric beam must be fitted correctly and tested for operation at regular intervals. Extreme caution is recommended when using auto close mode. All safety rules must be followed.
- Place opener in protected area so that it does not get wet.
- Do not spray with water .
- Disconnect the power cord from mains power before making any repairs or removing covers. Only experienced service personnel should remove covers from the opener.
- If the power supply cord is damaged, it must be replaced by an Automatic Technology service agent or suitably qualified person.
- Connect the opener to a properly earthed general purpose 240V mains power outlet installed by a qualified electrical contractor.



ELECTROCUTION!

- If garage has no pedestrian entrance door, an emergency access device should be installed. This accessory allows manual operation of the garage door from outside in case of power failure.
- Practice correct lifting techniques (carton weighs approx 5.7kgs)
- Practice correct lifting techniques when required to lift the door as per installation instructions.
- Ensure ladder is the correct type for job.
- Ensure ladder is on flat firm ground that will take the weight without the legs sinking.
- Ensure user has 3 points of contact while on ladder.
- Place a 2 metre exclusion zone around area under the door while it is unsecured.
- Follow the installation instructions
- Examine the door installation, in particular, springs and mountings for signs of wear, damage and imbalance.
- The garage door must be well balanced. Sticking or binding doors must be repaired by a qualified garage door installer prior to installation of the opener.
- Remove or disengage all garage door locks and mechanisms prior to installation of the opener.
- Never plug in and operate opener prior to installation.
- Keep hands and loose clothing clear of door and guides at all times.
- DO NOT operate the opener unless the garage door is in full view and free from objects such as cars and children/people. Make sure that the door has finished moving before entering or leaving the garage
- In order for the opener to sense an object obstructing the door way, some force must be exerted on the object. As a result the object, door and/or person may suffer minor damage or injury.
- Ensure the garage door is in good working order by undertaking regular servicing.
- Install the optional wall transmitter in a location where the garage door is visible, but out of the reach of children at a height of at least 1.5m.
- Photo Electric beams must be installed if the closing force at the bottom edge of the door exceeds 400N (40kg)



CAUTION:

Emergency Access

Muscular strain

Fall from ladder

Crush injury from unsecured door

Garage Door

Entanglement

Entrapment under operating door

- If garage has no pedestrian entrance door, an emergency access device should be installed. This accessory allows manual operation of the garage door from outside in case of power failure.
- Practice correct lifting techniques (carton weighs approx 5.7kgs)
- Practice correct lifting techniques when required to lift the door as per installation instructions.
- Ensure ladder is the correct type for job.
- Ensure ladder is on flat firm ground that will take the weight without the legs sinking.
- Ensure user has 3 points of contact while on ladder.
- Place a 2 metre exclusion zone around area under the door while it is unsecured.
- Follow the installation instructions
- Examine the door installation, in particular, springs and mountings for signs of wear, damage and imbalance.
- The garage door must be well balanced. Sticking or binding doors must be repaired by a qualified garage door installer prior to installation of the opener.
- Remove or disengage all garage door locks and mechanisms prior to installation of the opener.
- Never plug in and operate opener prior to installation.
- Keep hands and loose clothing clear of door and guides at all times.
- DO NOT operate the opener unless the garage door is in full view and free from objects such as cars and children/people. Make sure that the door has finished moving before entering or leaving the garage
- In order for the opener to sense an object obstructing the door way, some force must be exerted on the object. As a result the object, door and/or person may suffer minor damage or injury.
- Ensure the garage door is in good working order by undertaking regular servicing.
- Install the optional wall transmitter in a location where the garage door is visible, but out of the reach of children at a height of at least 1.5m.
- Photo Electric beams must be installed if the closing force at the bottom edge of the door exceeds 400N (40kg)

1. Safety Warnings! (for operation)

This automatic garage door opener is designed and tested to offer safe service provided it is installed and operated in strict accordance with the following safety warnings. Failure to comply with the following instructions may result in death, serious personal injury or property damage.

WARNING! IMPORTANT SAFETY INSTRUCTIONS

IT IS IMPORTANT FOR THE SAFETY OF PERSONS TO FOLLOW ALL INSTRUCTIONS.

SAVE THESE INSTRUCTIONS



WARNING!

- Automatic Door - the door may operate unexpectedly, therefore do not allow anything to stay in the path of the door.
- Details on how to use manual release. When operating the manual release while the door is open, the door may fall rapidly due to weak or broken springs, or due to being improperly balanced.
- **DO NOT** disengage the opener to manual operation with children/persons or any objects including motor vehicles within the doorway.
- If the door is closing and does not re-open when obstructed, discontinue use. **DO NOT** use a door with faulty obstruction sensing.
- Frequently examine the installation, in particular check cables, springs and mountings for signs of wear, damage or imbalance. **DO NOT** use if repair or adjustment is needed since fault in the installation or an incorrectly balanced door may cause injury..



ELECTROCUTION!

- Place opener in protected area so that it does not get wet.
- **DO NOT** spray with water .
- **DO NOT** open the protective covers.
- **DO NOT** operate opener if cable is damaged. It must be replaced by the manufacturer, its service agent or similarly qualified person in order to avoid a hazard.
- Disconnect the supply(s) when cleaning or other maintenance is being carried out..



DO NOT DO IT YOURSELF

- Keep the garage door balanced. Sticking or binding doors must be repaired. Garage doors, door springs, brackets and their hardware are under extreme tension and can cause serious personal injury. **DO NOT** attempt any garage door adjustment. **DO NOT** use if repair or adjustment is needed. Call for a professional garage door service.



BATTERY WARNING!

- This product contains a lithium button/coin cell battery in the transmitters. If a new or used lithium button/coin cell battery is swallowed or enters the body, it can cause severe internal burns and can lead to **DEATH** in as little as 2 hours. Always completely secure the battery compartment. If the battery compartment does not close securely, stop using the product, remove the battery and keep it away from children. If you think batteries might have been swallowed or placed inside any part of the body, **SEEK IMMEDIATE MEDICAL ATTENTION.**



CAUTION:

Emergency access

Entrapment under operating door

Fall from Ladder

Entanglement in or laceration from moving door

- If your garage has no pedestrian entrance door, an emergency access device should be installed. This accessory allows manual operation of the garage door from outside in case of power failure.
- Watch the moving door and keep people away until the door is completely opened or closed. **DO NOT** operate door when persons are near the door.
- **DO NOT** allow children to play with door controls or transmitters. Keep remote controls away from children.
- The appliance is not to be used by persons (including children) with reduced physical, sensory or mental capabilities, or lack of experience and knowledge, unless they have been given supervision or instruction.
- Children being supervised not to play with the appliance.
- Regularly conduct Open and Close cycle testing.
- Each month check that the drive reverses when the door contacts a 40mm high object placed on the floor. Adjust if necessary and recheck since an incorrect adjustment may present a hazard.
- Ensure the garage door is in good working order by undertaking regular servicing.
- Wall transmitters should be installed in a location where the garage door is visible, but out of the reach of children at a height of at least 1.5m.
- Install Safety Beams (recommended).
- Ensure ladder is the correct type for the job.
- Ensure ladder is on flat ground.
- Ensure user has 3 points of contact while on ladder.
- Keep hands and loose clothing clear of door and guides at all times.
- Keep hands clear of moving door as sharp edges can cause cuts or lacerations.

2. Before you Begin

2.1 Examine the conditions in the garage:

a. Look at the ceiling:

- Is it plastered? The opener is mounted to a perforated angle which **MUST** be securely fastened to a structural support. You will need to locate the structural beams in the ceiling which are generally 400mm apart.
- Does it have exposed beams? The opener is mounted to a perforated angle which must be securely fastened to a structural support like the exposed beams. You may need to install a 40mm thick board (not supplied) between structural supports.

b. Look at the wall above the garage door.

- Is it brick? The wall bracket **MUST** be securely fastened to the wall with suitable screws and ensure it does not move.
- Is it timber? The wall bracket **MUST** be securely fastened to a structural support. You may need to install a 40mm thick board (not supplied) between structural supports to fasten the wall bracket to.

2.2 Test the following before commencing installation:

- The door **MUST BE** in good operating condition.
- Manually move the door up and down, the door should move freely without binding or sticking. When the door is fully closed it should raise itself by 10cm off the floor. Retension door if necessary.
- The maximum force required to move the door should not exceed 20kg.
- Lift the door to about halfway. When released, the door should stay in place.

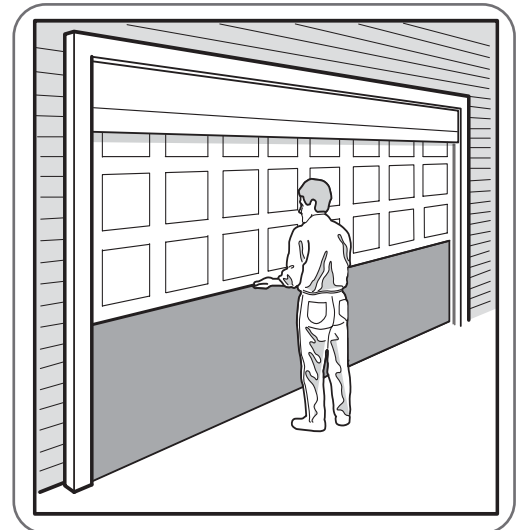

DO NOT DO IT YOURSELF:

If any of the above door requirements are not met, **DO NOT** attempt to fix yourself. Please contact a garage door professional. (P) 13 62 63

3. Tools Required

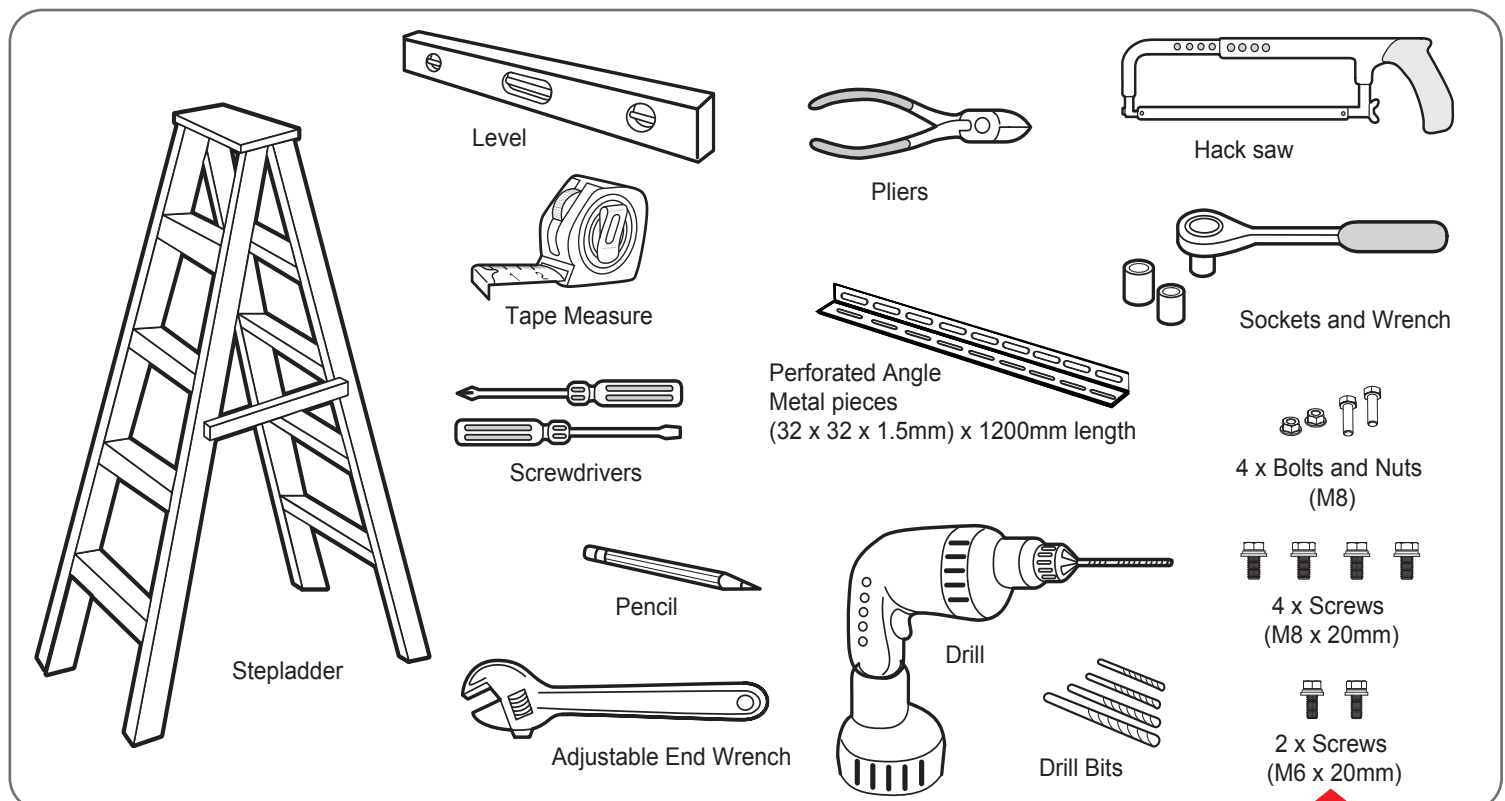

4. Kit Contents

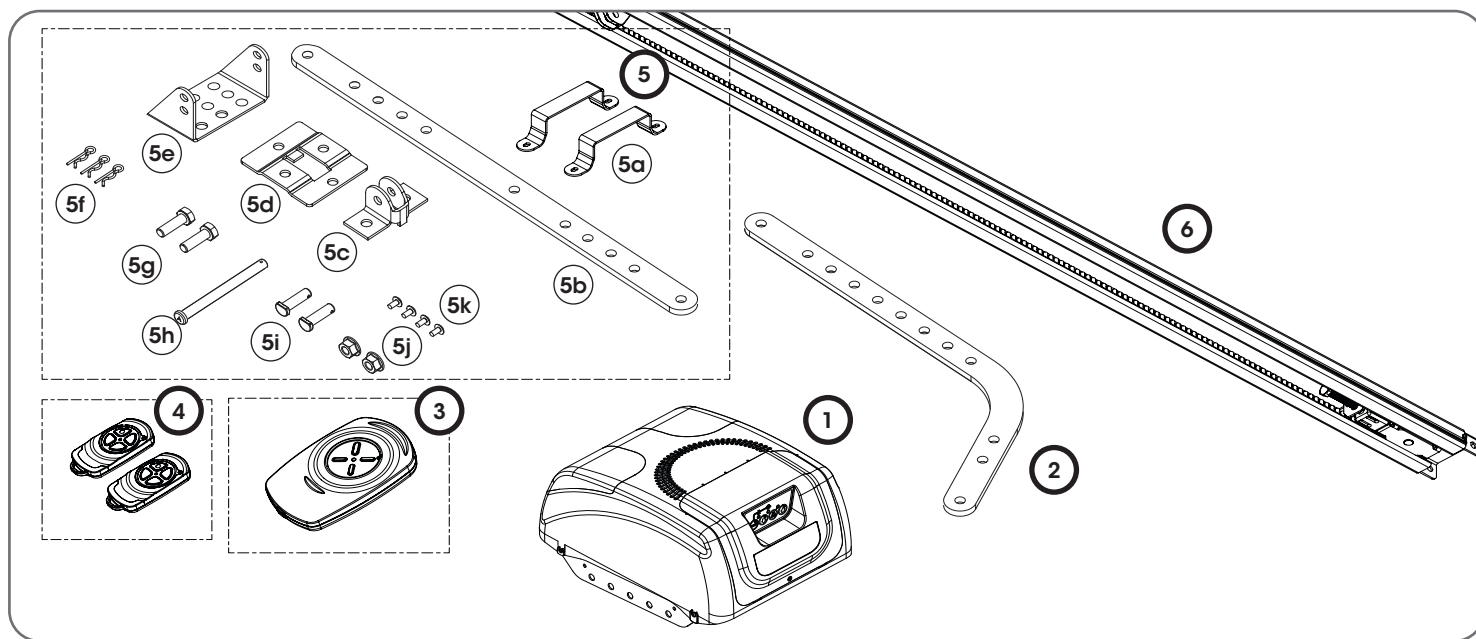

PLUS

- | | | | |
|----|------------------------------|----|-------------------------|
| 1. | 1 x SDO drive unit | 5. | 1 x Track Hardware Kit |
| 2. | 1 x Bent arm door attachment | 6. | 1 x Pre-Assembled track |
| 3. | 1 x Wall Transmitter | | |
| 4. | 2 x Transmitters | | |

5. Position

The Opener:

- MUST BE installed in a dry position, protected from weather.
- REQUIRES properly earthed 3 pin single phase power on the ceiling within an arms length of the opener.
- Requires a MINIMUM HEADROOM of 57mm between the highest point of the door's travel and the ceiling.
- Use the diagram below as a reference when completing the installation.

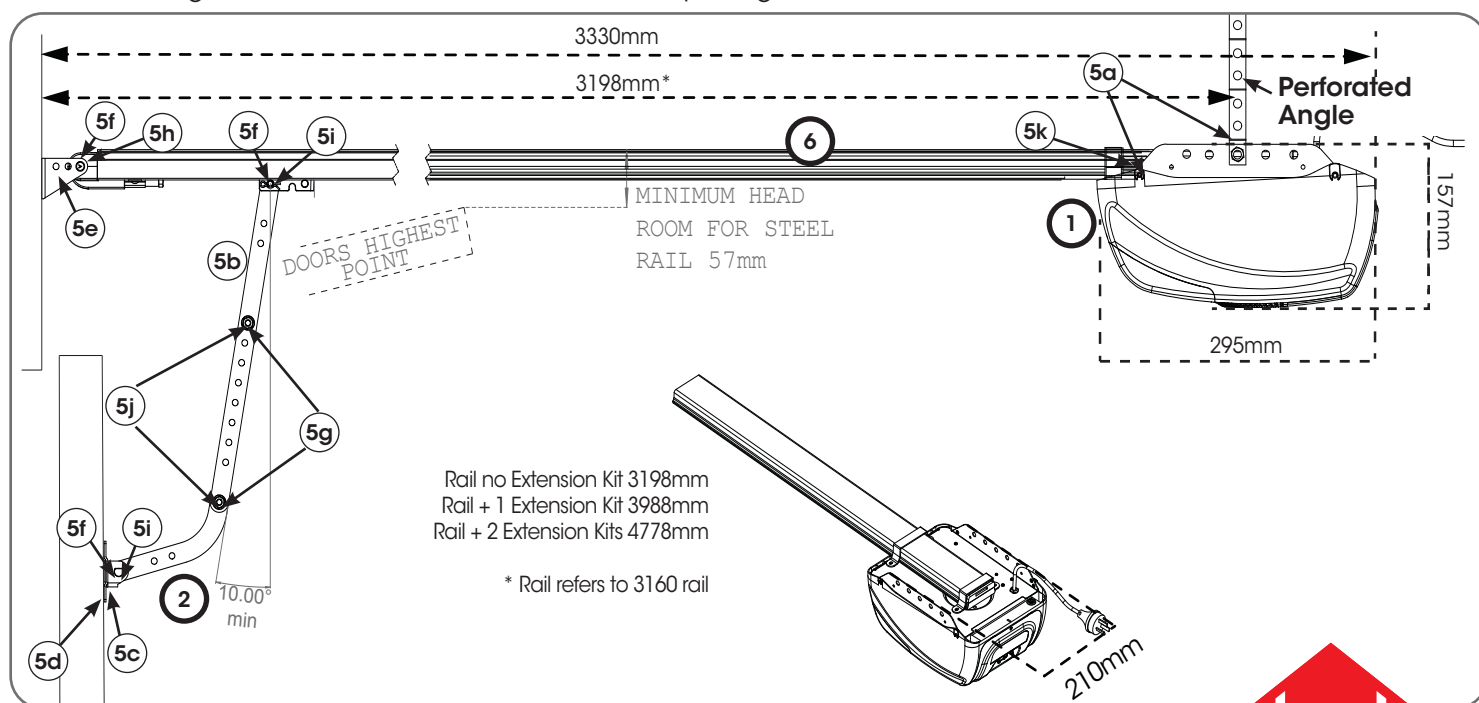

6. Fit the Opener

6.1 Secure C-Rail to Opener:

- Remove the Opener from the box, taking care of antenna (if fitted).
- Locate and insert the shaft of drive unit (1) into the C-Rail's sprocket.
- Fix the two track brackets (5a) with four (4) M4 x 8 screws (5k) supplied in accessory pack.
- Place drive unit back in packing box for protection.

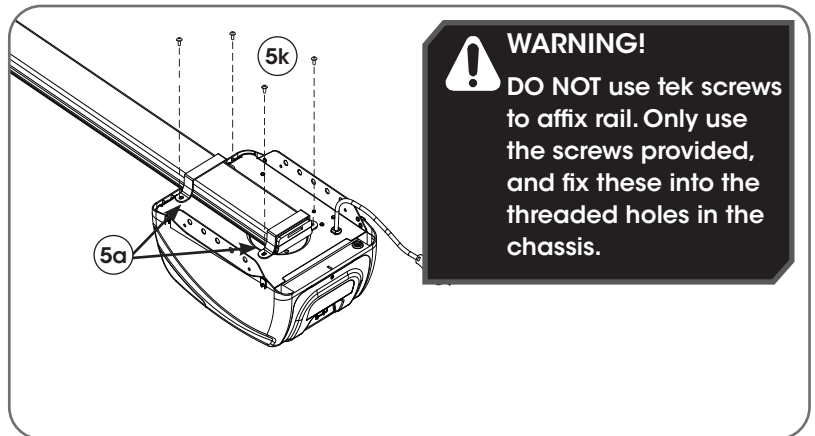
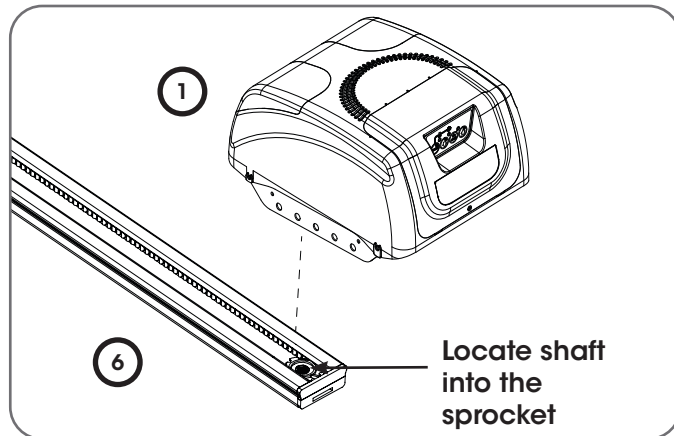

7. Bracket Position

7.1 Wall Bracket Position:

- Determine the centre of the door and mark this point with a line on the wall above.
- Raise the door and find the highest point of travel of the first (top) door panel.



WARNING! The Opener must be securely fastened to structural supports, otherwise opener failure may ensue causing serious personal injury and / or property damage.

- Using step ladder and a level, transfer this height to the wall above the door and mark a line 60mm above it, across the centre line.

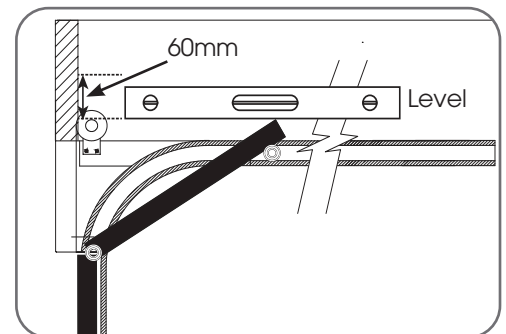

DO NOT DO IT YOURSELF: If sufficient structural support can not be found, contact a door professional for installation.

7.2 Mounting the Wall Bracket:

- Draw two lines extending 21.5mm from each side of the centre point.
- Centre the wall bracket (5e) over the intersection of these two lines. Mark centres for at least two holes and ensure it is into a solid mounting point.
- Drill holes in the wall with an appropriate bit.
- Secure to the wall using:
 - IF CONCRETE OR BRICK:
8mm (5/6") loxins/dynabolts.
 - IF TIMBER:
wood screw #20 or similar (min. 50mm).

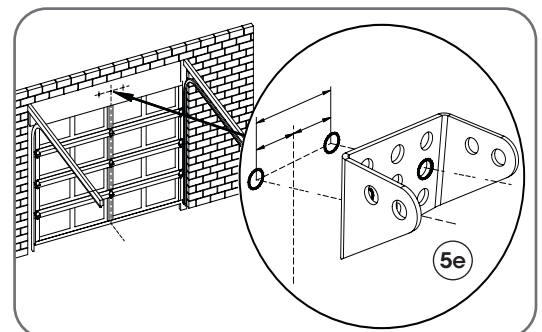

7.3 Attach the Track to the Wall Bracket

- Leave the drive unit in its packing box on the floor for protection and lift the other end of the C-Rail.
- Attach the pre-assembled track (6) to the wall bracket (5e) with the 90mm long pin (5h) and secure with the supplied pin snap (5f).

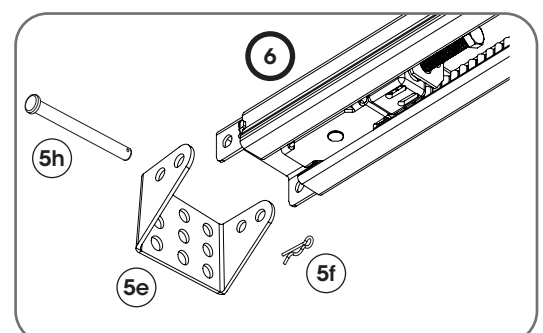

8. Perforated Angle (Not supplied)

8.1 Attach Perforated Angle or equivalent

- Measure across the ceiling from the centre point 3175mm (+/- 150mm) to find a supporting beam.
- Create a perforated angle which best suits your site. Use a hack saw to cut the L shape metal strips. Secure the perforated angle to a supporting beam using diagrams shown below.
- Raise the drive unit to the ceiling mounted perforated angle and secure with M8x20mm screws and nuts (not supplied). Strips should not extend more than 18mm below centre of drive unit mounting holes.
- To prevent moisture on the C-rail running into the powerhead it is recommended a strip of silicon sealant is placed across the top of the C-rail just before the opener.

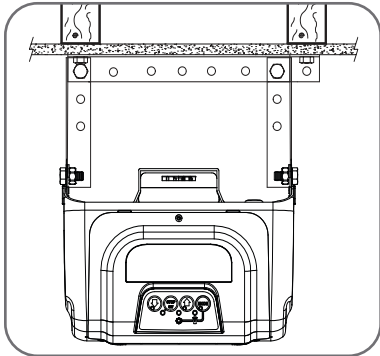

Ceiling Beams that run towards the door requires:
 1 x perforated L shape metal strip and
 2 x shorter perforate L shape metal drop down strips..

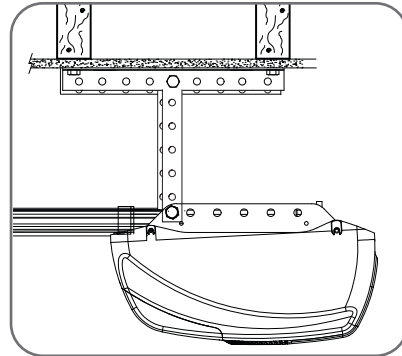

Ceiling Beams that run parallel to the door requires:
 2 x perforated L shape metal strips and
 2 x shorter perforate L shape metal drop down strips..

! tip Straighten the antenna on the opener, by pulling straight down to ensure optimal reception.

9. Mounting Brackets and Arms

9.1 Mounting the Door Bracket:

- The door bracket locator (5d) is placed over the door bracket (5c), on the door's centre line one-third down the top panel and mounted using M6 or equivalent screws (not supplied).
- STEEL DOORS ONLY:** Bracket can be welded in place.

NOTE: If in doubt about the door's strength, reinforcement may be added to the door's frame where necessary. Door damage may occur if the bracket is installed on a panel with insufficient strength. The opener's warranty does not cover damage caused to the door and/or door panels.

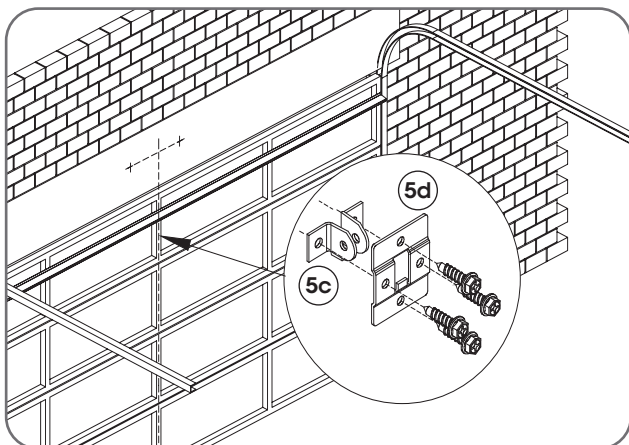

9.2 Attaching the Arms

- Assemble the bent arm (2) (connecting to the door) to the right side of the straight arm (5b) with bolts (5g) and nuts (5j). Connect the straight arm (5b) to the shuttle with a clevis pin (5i) and a pin snap (5f). Always use both bent and straight arms.
- Connect the assembled arm to the bracket with clevis pin (5i) and pin snap (5f). The angle "A" must be more than 10°.

! tip For J-Type doors: Refer to Appendix G for attaching arms

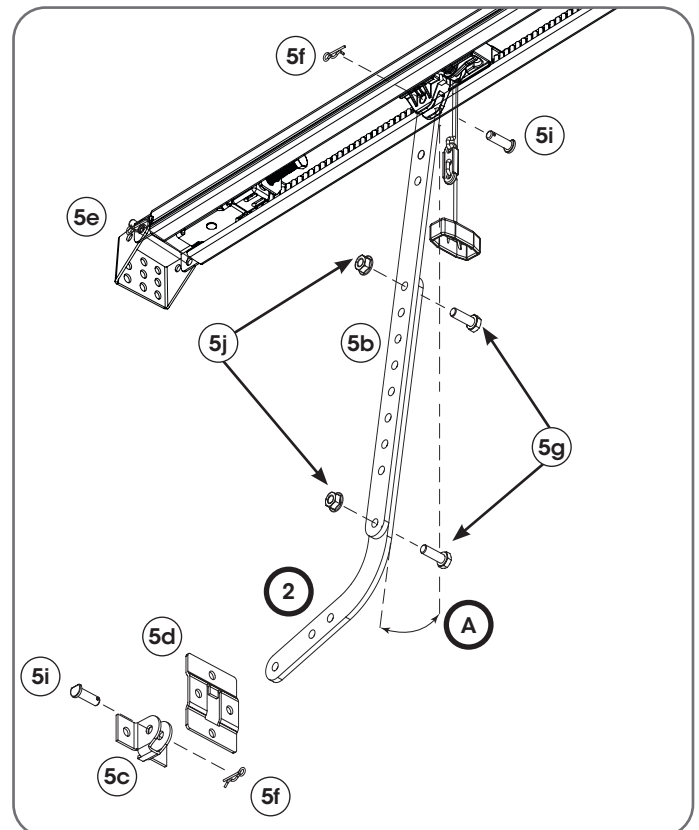

10. Optional Safety Beam Kit



WARNING! The Opener must be fitted with Safety Beams if:

- the closing force at the bottom edge of the door exceeds 400N (40kg) and/or;
- the opener has a smart device fitted to operate the door, when not in line-of-sight.



CAUTION! The Safety Beam must be installed and connected before the travel limits are set.

10.1 Inserting batteries into receiver and transmitter

- Insert two (2) C-Type batteries into the Receiver (RX) and the Transmitter (TX) by removing the front cover.
- Put cover back on Transmitter and Receiver and secure with four (4) M6 x 25 screws (black).

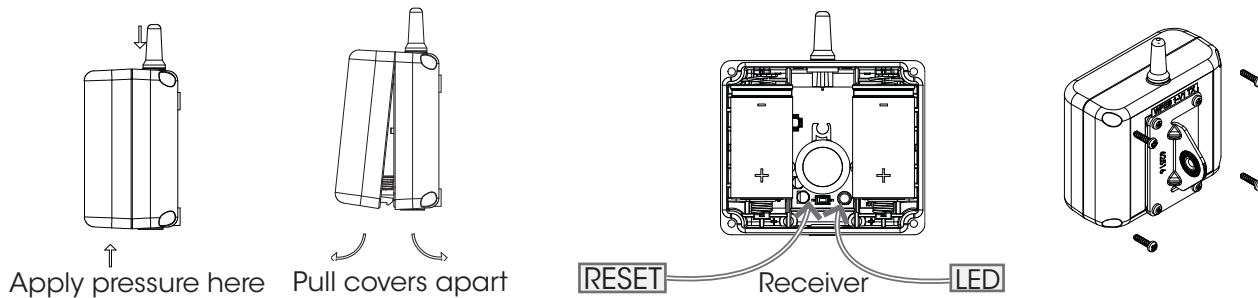

10.2 Assemble the Mounting Bracket

- Attach the PE 2000TS Bracket (1) to the Safety Beam Transmitter (TX) using four (4) M3 x 5 Taptite screws (4).
- Connect the mounting bracket (3) to the adjustment bracket (2) with two (2) of the M5 x 10 Pan Head Screws (5).
- Repeat steps (a) and (b) to assemble the Safety Beam Receiver (RX).
- Mount the receiver on the side of the doorway in shade and the transmitter on the other side in line with the receiver. The mounting surface should be rigid. Affix with a minimum of four (4) screws (not supplied).

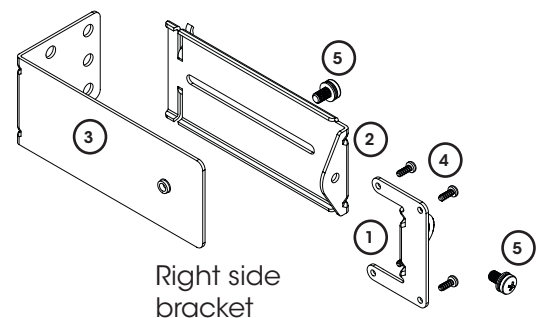

10.3 Mounting the Bracket

The transmitter and receiver need to be placed in line of sight, with the beam 100mm above the ground level (as per AS/NZS 60335-2-95:2020). This can be achieved by ensuring the bottom of the receiver and transmitter are 65mm above ground level. They should also be placed as close as possible to the door opening with the receiver (RX) in shade and the transmitter (TX) in sun or shade.

Assembling Flush Mounting Kit (for minimum sideroom applications)

- Attached the transmitter (TX) and receiver (RX) to the two (2) PEB4-W1 Bracket (1) with the four (4) M3 x 8 Taptite screws "P" (4).
- Ensure to take note of the ATA recommendation in step (d) above and fix the TX and RX to the wall or rigid surface using the two (2) 6.9 x 25 plastic wall plugs (if wall) and two (2) M6 x 25 self tapping screws.

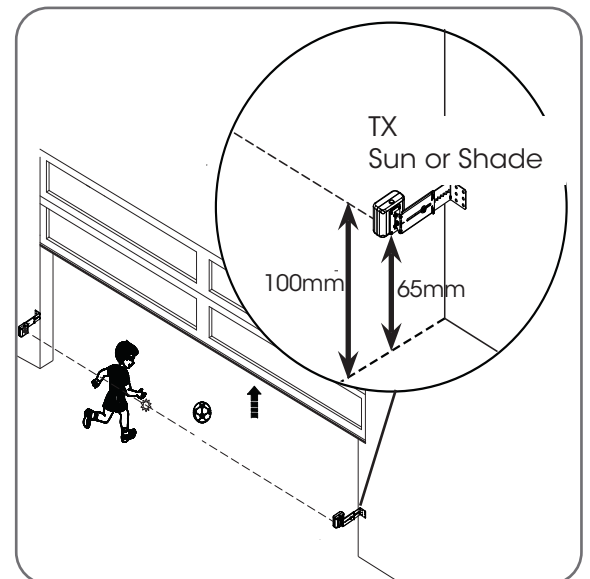

10.4 Aligning the Transmitter and Receiver

- Power up the opener with the safety beams connected.
- The LED on the receiver and transmitter will light up and flicker, indicating communication is being established between each unit and the base station. This can take up to 60secs. Lights will:
 - Stay on solid = When communication is established but limits are not set.
 - Go out = When communication is established and limits are set.
- The opener beam alignment feature can be used to align beams via the beeper and main light as a guide;
 - bright = aligned
 - dull and Beeper sound = not aligned or blocked.

When the beams are aligned, continue with Section 12 Setting Limits.



If the lights does not dim and the beeper does not sound when an object blocks the beam then the beam is not being detected by the opener. - check the PE beam wiring, batteries and alignment.

11. Specifications

Technical Specifications	PanelMax™ SDO-8V3
Rated voltage range:	230V - 240V.
Rated frequency:	50Hz
Rated power input:	195W
Door opening: Maximum Door Area: Maximum Door Weight:	16.5m ² 140kg*
Door must be well balanced and able to be operated by hand, as per warranty conditions and AS/NZS 4505:2012	
Minimum headroom	57mm
Rated Operating Time	4 mins
Rated Temp	+5°C to +40°C
Short Term Peak force:	700N
Door travel speed (mm/sec)	180mm
Rated load	400N
Maximum lifting under spring tension	200N (20kg)
Receiver type	Multi-frequency UHF FM
Receiver code storage capacity	64 X 4-button Transmitters
Transmitter battery	CR2032 (3 Volts)
Courtesy light	LED (Light Emitting Diodes)
Network connectivity	Network ready (requires optional smart phone control kit)





* Gross door weight, including all fittings

Note: During the open and close cycles, intermittent operations may occur in areas which experience very strong winds. The strong wind puts extra pressure on the door and tracks which may in turn intermittently trigger the safety obstruction detection system.

12. Setting Limits

12.1 Set the Limit Positions and adjust drive speed:

tip When setting the Close limit, ensure the position is when the door makes first contact with the ground. Alternatively for the Open limit the position should be at the height of the garage opening.



STEP ONE	STEP TWO
 <p>Switch power on</p>  +  <p>BLUE LED will flash & gear LED lit</p>	 OR  <p>To move the door to the halfway point.</p>



CAUTION! Limit setup is not available when running on battery backup



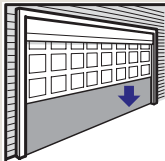

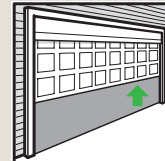

tip Refer to Appendix F for setting limits via a transmitter. **NOTE** - Speed of the opener can not be adjusted when using this method.







NOTE: The drive speed is set to the fastest setting by default. This may not be suitable for larger doors or for single piece doors. For tilt doors (J-Type only), please refer to **Appendix G** for initial setup.

tip Refer to Appendix B & C for adjustments to margins and Appendix E to set the PET Mode position



CLOSE LIMIT POSITION	
STEP ONE	STEP TWO
 <p>HOLD</p>  <p>Take note of the speed as door moves</p>	<p>If Close speed not suitable, release button, THEN</p>  +  <p>HOLD Each press changes speed as per table</p>

OPEN LIMIT POSITION	
STEP ONE	STEP TWO
 <p>HOLD</p>  <p>Take note of the speed as door moves</p>	<p>If Open speed not suitable, RELEASE button, THEN</p>  +  <p>HOLD Each press changes speed as per table</p>

MAIN LIGHT & BEEPER	SPEED MODE
 x 3 + 3 x 	FAST (Default)
 x 2 + 2 x 	MEDIUM
 x 1 + 1 x 	SLOW

MAIN LIGHT & BEEPER	SPEED MODE
 x 3 + 3 x 	FAST (Default)
 x 2 + 2 x 	MEDIUM
 x 1 + 1 x 	SLOW

STEP THREE	STEP FOUR
 <p>RELEASE</p> <p>When at desired speed</p>  <p>HOLD</p> <p>Press to close door</p>	 <p>When door near close, single presses inch door</p> <p>CLOSE limit should be when rubber strip touches the ground</p>

STEP THREE	STEP FOUR
 <p>RELEASE</p> <p>When at desired speed</p>  <p>HOLD</p> <p>Press to open door</p>	 <p>When door near open, single presses inch door</p> <p>OPEN limit should be the height of the garage opening</p>

WARNING! In setting the close limit position, do not force the door into the floor with excessive force, as this can interfere with the ease of operation of the manual release mechanism.





WARNING! The door will automatically close, open and close again after the next step. Ensure that nothing is in the door's path.

STEP FIVE
<p>If door overshoots</p>  <p>Press</p>  <p>Press to position</p>  <p>Press to set</p>

STEP FIVE
<p>If door overshoots</p>  <p>Press</p>  <p>Press to position</p>  <p>Press to set</p> <p>Door will open & close to calculate safety obstruction settings</p>

NOTE: If unhappy with the speed or travel limit setting, restart this procedure by resetting the door limit positions as per below first.





12.2 Clearing the Door Limit Positions

STEP ONE		STEP TWO	
Remove controls cover			
 Press repeatedly	 till gear LED lit	 HOLD for 10 sec	 Release when light stops flashing
STEP THREE			
		NOTE: No action taken within 30 secs, the opener returns to original settings.	
The BLUE LED flashes continuously to show limits cleared		SET Close & Open limits	

12.3 Re-profiling the Door

tip Re-profiling is a simple way of re-learning the travel characteristics of a previously setup Limit Switch travel. Re-profiling is used when travel characteristic change due to mechanical adjustments.

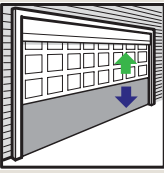

To initiate a re-profile: LIMITS must already be set.

STEP ONE		STEP TWO	
Remove controls cover			
 Press repeatedly	 till gear LED lit	 HOLD for 2 secs	 Door will open and close
STEP THREE			
 Press to exit	 OFF	Then refit controls cover	

12.4 Controller memory reset

To clear the controller:

tip If limits are already set, clear limits first by following Clearing the door limit positions and then follow below.

STEP ONE		STEP TWO	
When in limit setting mode			
		 Release	
The BLUE LED flashes continuously to show limits clear		 HOLD for 10 sec	
This will cause all control memory to be set to factory defaults EXCLUDING: transmitters, history log and cycle counters.			

13. Safety Testing

13.1 Test the Close Cycle

- Press the OPEN button  or transmitter button to open the door (If the door starts closing, press the transmitter button to stop the door, then press transmitter again to open).
- Place a piece of timber approximately 40mm high on the floor directly under the door.
- Press the transmitter button to close door.
- The door should strike the object and re-open.
- Remove the timber .

WARNING! If the door is closing and is unable to re-open when obstructed, discontinue use Do not use a door with faulty obstruction sensing.

13.2 Testing the Open Cycle

- Press the CLOSE button  or transmitter button to close the door.
 - Press the transmitter button again to open the door.
 - When the door reaches approximately half way, firmly grab the door's bottom rail - the door should stop.
- If the door does not reverse readily when closing, or stop when opening, put the door into manual by pulling down on the manual release string to disengage the motor and contact 13 62 63 for support.

13.3 Test the Manual Door Operation

A poorly maintained door could cause fatal / serious injuries or damage to property:

- Frequently examine the door, particularly the cables, springs and mountings for signs of wear, damage or imbalance. **DO NOT USE** if repair or adjustment is needed since a fault in the installation or an incorrectly balanced door may cause injury.
- Fasteners: Check all screws, nuts and bolts to ensure they are secure.
- Spring Tension: It is natural for springs to lose tension. Should the door become hard to operate or completely inoperative, contact a door professional.
- Guide Tracks: Clean the internal sections of the guide tracks every 3 - 6 months with a cloth dampened with mineral turps or methylated spirits.
- Periodically disengage the opener and manually operate the door. The door must be smooth to operate by hand. The force required on the bottom rail should not exceed 20kg.

CAUTION: Take care when completing a safety test. Failure to follow this warning can result in serious personal injury and/or property damage.

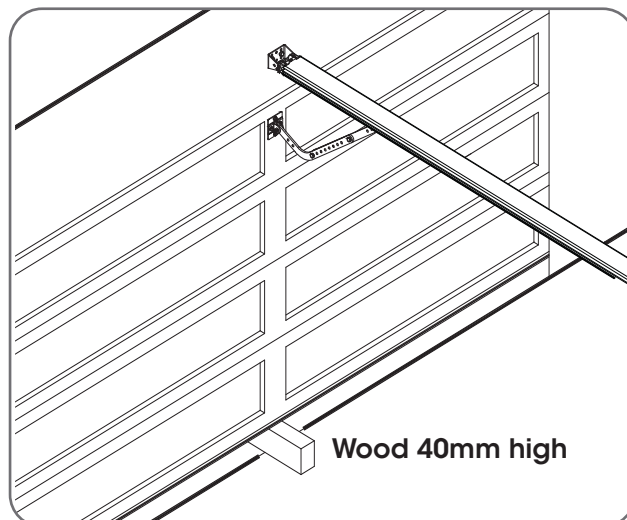

WARNING! If the door fails these tests, put the opener into manual mode, only operate the door by hand and call for service.

WARNING! Safety beams must be installed if the closing force at the bottom edge of the door exceeds 400N (40kg).

14. Auto-Close

14.1 Auto-Close

Auto-Close mode is a function that automatically closes the door after a pre-set time. Safety beams must be installed in order to run the Auto-Close function. There are two types of Auto-Close available:



i. Standard auto-close - the door will Auto-Close after a programmed time. In this mode the timer starts to countdown as soon as the door is fully open. This function is useful in case the safety beam does not get triggered.

NOTE: Auto-Close will not function if the door reversed after hitting an obstruction or stalling.

ii. Safety Beam triggered auto-close - the door will auto-close after a programmed time. In this mode the timer starts counting down only when the safety beam is triggered. ie car leaving the garage.



WARNING! It is compulsory to have Safety Beams installed when using Auto-Close mode.

STEP ONE

Remove controls cover →  →  till gear LED flashing

Press repeatedly

STEP TWO

 →  until gear LED flashes

Press repeatedly

x 2 PE Auto
x 3 Std Auto

STEP THREE

 Press to enter parameter



Default setting for Auto-Close is OFF.

Value options = Indicated by brightness of main light



Parameter		1	2	3	4	5	6
PE AUTO-CLOSE	x2	OFF	15sec	30sec	60sec	90sec	-
AUTO-CLOSE	x3	OFF	15sec	30sec	60sec	90sec	120sec

STEP FOUR

 →  Press to save
 OR
 Press to leave unchanged

Press to move through options as per table



14.2 Terminal Block

Wired accessory items can be connected to the terminal block **J4**. Terminal connections from top down are as follows:

- a. **+35V** (Auxillary)
- b. **AUX** (Auxillary)
- c. **SB** (Safety Beam input, mandatory);
- d. **GND** (Common ground for accessories and Safety Beam);
- e. **GND** (Common ground)
- f. **OSC** (Open/Stop/Close trigger)

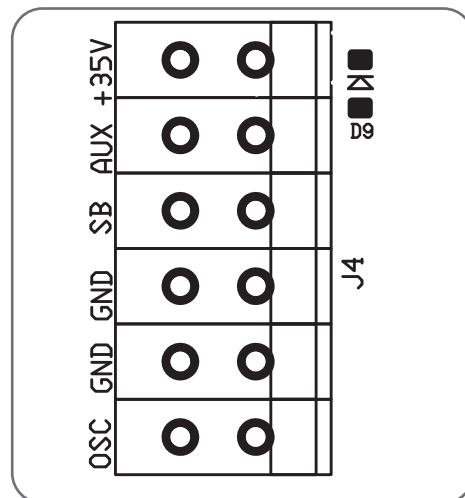

14.3 Connecting or Disconnecting Accessories

The opener can hold up to 4 accessories. For example Secure;

- Auto-Lock
- Wireless PE Beams
- Smart Hub



If an Auto-lock and Wireless PE Beams are both installed ensure that the channels on the base stations on each device are different. The channel on the base station can be changed by sliding the switch in either direction

STEP ONE

Remove controls cover

Press repeatedly

till gear LED lit

STEP TWO

HOLD for 2 secs

till 3 beeps are heard

STEP THREE

For PE Beams

Alignment Mode is entered. Ensure Alignment.

Then replace controls cover

Re-registering is required every time an accessory is removed.



15. Coding a Transmitter

15.1 Storing the Transmitter Code



The opener can only be operated from remote controllers that have been programmed into its memory. Up to 64 remotes can be programmed.

STEP ONE	STEP TWO
 Switch power on and remove controls cover	 Press repeatedly
 till remote LED lit	 Then refit controls cover
STEP THREE	STEP FOUR
 HOLD	 HOLD for 3 sec RELEASE HOLD for 3 sec
Opener flashes & beeps	Release both buttons
STEP FIVE	
 Press to test	

NOTE: To code other transmitter functions, at STEP THREE refer to below table of buttons to press.

TRANSMITTER FUNCTION	BUTTON		
Open / Stop / Close	HOLD		
PET (Pedestrian) Mode		HOLD	
Open			HOLD
Light	HOLD	HOLD	
Vacation Mode	HOLD		HOLD
Aux Output		HOLD	HOLD

* The button coded for open only function can close the door if you hold the button for 4 seconds, when the door is fully open..

NOTE: The opener will flash and beep during coding, refer to below table for status indication..

MAIN LIGHT & BEEPER	TRANSMITTER STATUS
ON + 2 x	Button added
OFF + 2 x	Button removed
x 2, then OFF + 2 x	Remote control deleted
x 4, then OFF + 4 x	Memory full

15.2 Remotely Coding Transmitters



Remotely coding works when you have a pre-coded remote control and are in range of the opener.

STEP ONE	STEP TWO
 Take a pre-coded remote and press the button to duplicate	 Use a pen, HOLD for 2 sec the middle button through the coding hole
STEP THREE	STEP FIVE
 Opener flashes & beeps	 Opener stops flashing & beeping
Take new remote	Press to test







Remote code set is disabled when:







- powered by battery backup
- the service indicator is active
- when the door is indicating that it was prevented from closing by a P.E beam being blocked







15.3 Erasing All Transmitter Codes

<p>STEP ONE</p> <p>Remove controls cover</p>	<p>STEP TWO</p>  <p>Press repeatedly</p>  <p>till remote LED lit</p>
<p>STEP THREE</p>  <p>HOLD for 10 sec</p>  <p>Release when flashing and beeping stops</p>	<p>STEP FOUR</p> <p>Follow Section 15.1 to store new transmitter codes</p>

15.4 Vacation Mode

<p>STEP ONE</p> <p>Remove controls cover</p>	<p>STEP TWO</p>  <p>Press repeatedly</p>  <p>till remote LED lit</p>
<p>STEP THREE</p>  <p>HOLD</p> <p>Opener flashes & beeps</p>  <p>HOLD for 3 sec RELEASE HOLD for 3 sec</p> <p>Release all buttons</p>	
<p>STEP FOUR</p> <p>Then refit controls cover</p>	<p>STEP FIVE</p> <p>Turn on</p>  <p>HOLD for 4 sec RELEASE</p> <p>Turn off</p>  <p>Press, then try another remote</p>

15.5 Installing the Wall Mounted Transmitter

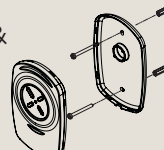
<p>STEP ONE</p> <p>Remove controls cover</p>  <p>Press repeatedly</p>  <p>till remote LED lit</p>	<p>STEP TWO</p>  <p>HOLD</p> <p>Opener flashes & beeps</p>  <p>HOLD for 3 sec RELEASE HOLD for 3 sec</p> <p>Release both buttons</p>
<p>STEP THREE</p> <p>Then refit controls cover</p>	<p>STEP FOUR</p> <p>Mount in view of door, away from children & at least 1.5m above floor.</p> 

16. Opener Safety & Security

16.1 Your Door CAN NOT be used by the opener when:

- There is a locking device installed.
- There is a power failure.

16.2 Your Door CAN be used when:

- There is an emergency, by disengaging the opener.
- There is a power failure, by disengaging the opener.

16.3 To Disengage the Opener:



It is recommended to disengage the door with the door in the closed position.

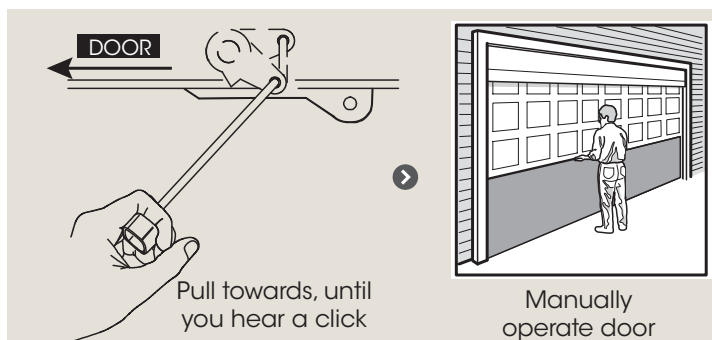

CAUTION: When the opener is manually disengaged, the door is no longer locked. To lock the door manually, re-engage the opener after the door is closed.



WARNING! When operating the manual release (while the door is open) the door may fall rapidly due to weak or broken springs, or due to being improperly balanced.

Do not disengage the opener to manual operation with children/ persons or any objects including motor vehicles within the doorway.

16.4 To Re-engage the Opener:

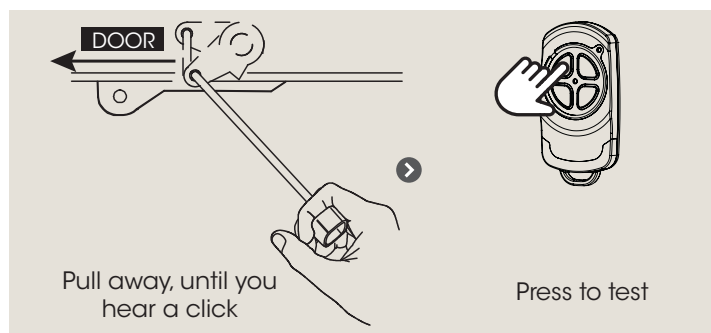

CAUTION: Do not use the string handle as a mechanism to open the door. Failure to comply may cause serious injury.

17. Operating your Opener

17.1 To Operate the opener:

- Press the programmed transmitter button until your door begins to move (usually 2 seconds). Make sure you can see the door when you use the transmitter.
- If you are in a vehicle you should aim the transmitter through your windscreen as shown.
- Check that the door is fully open or closed before you drive in or away.
- If you press the transmitter whilst the door is moving the door will stop. The next press of the transmitter will move the door in the opposite direction.

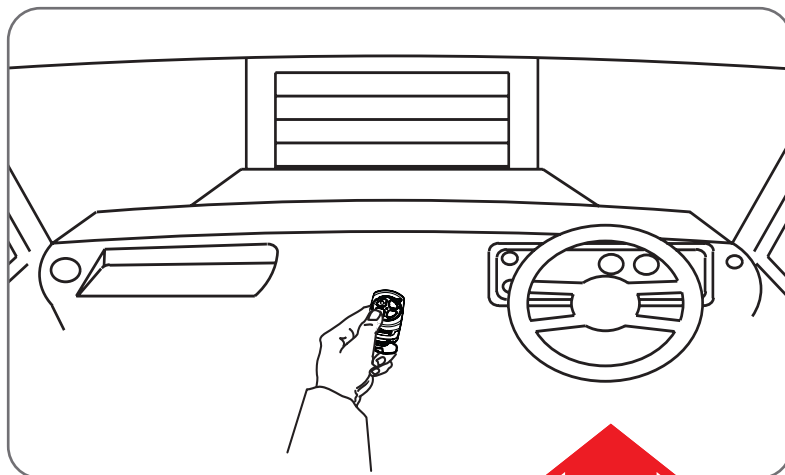

18. User Operating Controls

Button	Function
1. DOWN ARROW (Blue)	Closes the door
2. DOWN ARROW LED (Blue)	Illuminates when the door is closed and flashes when the door is obstructed on close or stopped.
3. STOP (Red)	Stops the door
4. UP ARROW (Green)	Opens the door
5. UP ARROW LED (Green)	Illuminates when the door is open and flashes when the door is open with the auto-close timer running, obstructed on opening or stopped.
6. MODE (Yellow)	Enables Load Diagnostics Mode
7. MODE STATUS LED (Yellow)	Illuminates when in Diagnostics Mode
8. REMOTE CONTROL STATUS LED (Red)	Flashes on remote lockout and flickers on remote control activity
9. ADJUSTMENT LED (Yellow)	Flashes a certain number of times depending on the parameter being changed.

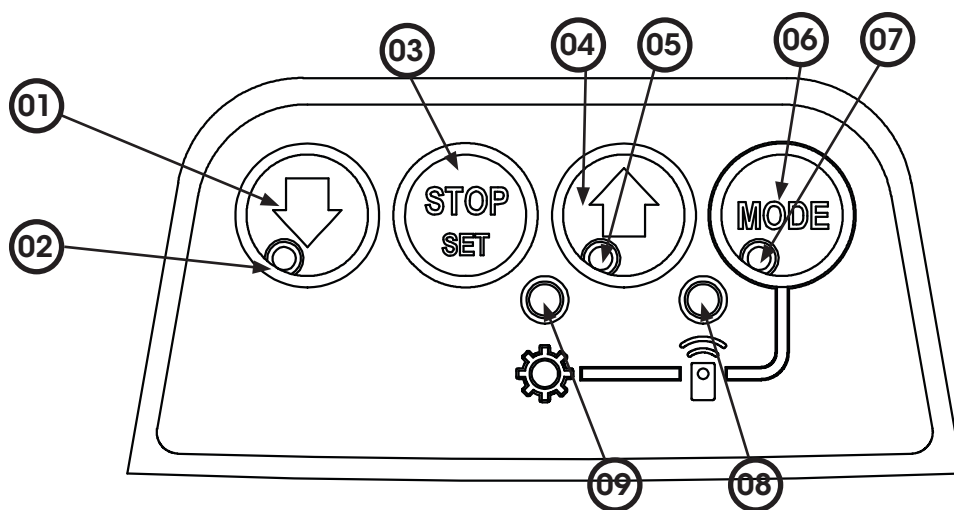









19. Troubleshooting

Symptom	Possible cause	Remedy
The opener does not work from the transmitter	Garage door in poor condition e.g. springs may be broken The opener does not have power The battery in the transmitter is flat The opener has turned on "Vacation Mode" The transmitter button is not programmed to operate the door.	Check the door's operation Plug a device of similar voltage (e.g. a hairdryer) into the power point and check that it is OK Replace the battery Turn off "Vacation Mode" (Section 15) Code in the transmitter
One transmitter works but the other/s do not	Faulty transmitter Flat battery	Replace transmitter Replace battery
The chain / belt moves but the door remains stationary	The opener is disengaged	Re-engage the opener
Motor is running but chain / belt is not moving	Damage motor assembly	Contact your dealer for support.
The transmitter range varies or is restricted	Variations are normal depending on conditions e.g. temperature or external interference The battery life is exhausted Position of the transmitter in the motor vehicle	Make sure you can see the door when you use the transmitter. Check the battery status by pressing a button (flashing or no light, battery need changing) Aim the transmitter through the windscreen.
The Courtesy light does not work	LED has failed	Change LED.
The door reverses for no apparent reason	This may occur occasionally from environmental conditions such as areas that are windy, dusty or have extreme temperature changes. If Safety beams are installed they may be partially obstructed.	Ensure the door runs smoothly before increasing the force pressure. Ensure the beam path is not obstructed. Check the Alignment.
Door will not close	Safety Beam not working Safety Beam battery flat	To access safety close mode, hold the transmitter button to close for 6 seconds and continue to hold while the door closes. Check Safety Beam
Auto Close not working	Safety Beam or wiring faulty	Repair Safety Beam or replace wiring. Re-align optics. See Safety Beam instructions.
The CLOSE (Blue) LED is flashing	Limits are not set	Set Up Limits (Section 12).

19. Troubleshooting

Main Light = Service / Warning Indicator:

Requirements for a service and user warnings are indicated after operation by the main light repeatably flashing OFF a number of times followed by a pause. When the alert is first triggered the beeper will also sound. The below table identifies the issues and remedies.







Flashes	Issue	Remedy
 x 2	PE is preventing door from moving	Clear away any obstructions. Test Door. If unable to move the door and suspect beam is faulty, enter Safety Beam Emergency Close by pressing and holding a pre-coded button on transmitter for more than five seconds and the door will start closing.
 x 3	Wireless LOCK battery is low	Change LOCK battery
 x 4	Wireless PE battery is low	Change PE Battery
 x 5	Wireless LOCK is not unlocked and preventing door moving	Check LOCK, test by pressing emergency release button on the lock and then test door operation.
 x 6	Maintenance is due after pre-set number of cycles.	Contact dealer to arrange service.
 x 7	Backup battery is faulty	Contact 1300 769 850 within Australia for assistance
 x 8	Door has hit an obstruction	Clear away any obstructions and test door opens/ closes correctly. (If door is damaged, contact your door professional)
 x 9	Motor has overloaded or stalled	Check the doors operation by disengaging the motor and ensuring the door runs smoothly. If necessary make door adjustments or contact your door professional.

Accessories (Auto-Lock, PE beam, Battery Backup etc):

Refer to Section 14 for tips, solutions and information on accessories.

Main Light = FAULT Status Indicator (when MODE is on):

When MODE is ON, light flashes indicated number of times. When first triggered, the beeper will sound the indicated number of beeps. Attempting to operate the door will result in the beeps being heard again. The below table identifies the issues and remedies.

Flashes	FAULT
 x 2 or x 3	Failed while profiling door after setting limits. Can be caused by any event which cause door to stop. For example PE beam being blocked on closing, hit an obstruction, etc. Also can occur if battery is activated.
 x 4 or x 5	Position Fault
 x 6	Motor driving in wrong direction
 x 7	Memory fault
 x 8	Motor current sensor fault.
 x 9	Motor drive fault

If You Need a Service Call

If the opener needs a service please call the dealer who installed the garage door opener (their contact details are usually on a sticker on the back of your garage door). For product assistance contact 13 62 63 within Australia.

BEFORE CALLING you should have the following information to assist in providing the appropriate service:

1. Has anything happened since the opener last operated OK, e.g. a storm, a jolt to the door etc.?
2. What is the current light status on the opener?
3. Manually disengage the door (Section 18). How easy is it to manually open and close the door?
4. What model is the opener? (Model no. information is located at the rear of the opener)
5. Who installed the opener? (Dealer details should be on a sticker on the back of your garage door)
6. When was it installed? (If known)

20. After Installation Care

20.1 Service Checklist

Preventative servicing of your garage door and opener, is just as important as servicing your car. Much like the engine of your car, your garage door is made up of numerous moving parts designed to lift and lower your door safely and efficiently.

Ongoing preventative servicing ensures that your door continues to function within factory specifications, greatly reduces the risk of failure and repair bills down the track and ensures you maintain your Warranty.



Run the Safety Testing procedures MONTHLY in Section 13 to ensure garage door is fit for use.

WARNING! Failure to maintain your your garage door voids the warranty on your garage door opener.

DO NOT DO IT YOURSELF: Door adjustments should only be carried out by experienced persons, as this function can be dangerous if not performed under strict safety procedures.

TECHNICIAN CHECKLIST

1. Lubrication of the critical moving parts including chain drive, tracks, wheels or cable drum.
2. Tightening of door mounting points along with door bolts, screws, cables and connectors.
3. Adjustment of spring tension to limit 'spring fatigue'.
4. Adjustment of opener travel limits and force margin to ensure the door opens and closes to specification.
5. Assessment and adjustment of safety components and accessories including safety beams, Auto-Lock and Safe Lock (if installed)
6. Assessment of the door alignment and the diagnosis of irregular operation remedies.
7. Record Cycle count at each service to establish next date of service (as per table)

	SERVICE 1 (12 months after installation or 3,000 cycles)		SERVICE 2 (3 years after installation)		SERVICE 3 (5 years after installation)	
DATE:						
BUSINESS NAME:						
TECHNICIAN NAME:						
PG3 COUNTERS	OPEN	CLOSE	OPEN	CLOSE	OPEN	CLOSE
STALLS						
OBSTRUCTIONS						
SENSOR FAULTS						
OVERLOADS / CUT-OUTS						
WARRANTY CYCLES						
FIRMWARE UPDATE AVAILABLE? IF 'YES' PLEASE UPDATE FIRMWARE	YES	NO	YES	NO	YES	NO
CURRENT FORCE MARGIN						
TECHNICAL SIGNATURE:						

	SERVICE 4 (7 years after installation)		SERVICE 5 (9 years after installation)	
DATE:				
BUSINESS NAME:				
TECHNICIAN NAME:				
PG3 COUNTERS	OPEN	CLOSE	OPEN	CLOSE
STALLS				
OBSTRUCTIONS				
SENSOR FAULTS				
OVERLOADS / CUT-OUTS				
WARRANTY CYCLES				
FIRMWARE UPDATE AVAILABLE? IF 'YES' PLEASE UPDATE FIRMWARE	YES	NO	YES	NO
CURRENT FORCE MARGIN				
TECHNICAL SIGNATURE:				



20. After Installation Care

20.2 Battery Replacement

STEP ONE		Light Status	Battery
 <p>Check Light Status Table</p>	Solid	OK	
	Flashing	Replace	
	No light	Replace	

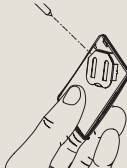
STEP TWO	STEP THREE
 <p>Use screwdriver to remove sciew and open</p>	 <p>Use non-metallic object to push out.</p>

WARNING! The battery is hazardous and must be kept out of reach of children. The battery can cause severe or fatal injuries within 2 hours or less if swallowed or placed inside any part of the body. If you suspect the battery has been swallowed or placed inside any part of the body, **SEEK IMMEDIATE** medical attention.

20.3 Battery Disposal

When batteries reach the end of their usual life in accordance with Australian Battery Recycling Initiative please follow the next simple steps for protecting the environment.

WARNING! The Battery shall be disposed of properly, including keeping them away from children. Even used batteries may cause injury.

DO NOT throw the batteries in municipal waste. This symbol of the crossed out wheeled bin indicates that the battery should not be placed in the municipal waste. Check your local regulations for appropriate disposal of the batteries.

Recycling all batteries will have other environmental and social benefits:

- Some batteries are less toxic but hazardous for other reasons. Lithium batteries can explode or catch fire in landfill, while button cells are dangerous if swallowed by children. Recycling offers a safe and environmentally responsible solution for end of life batteries.
- Battery recycling recovers non-renewable materials such as lead, cadmium, stella, zinc, manganese, cobalt, silver, plastics and rare earth elements.
- Removal of batteries and other hazardous household products from household waste facilitates the recovery of organic materials through alternative waste technologies such as composting. Batteries and heavy metals are known contaminants in compost.
- The community supports recycling because it reduces waste to landfill and achieves environmental benefits.

WARNING! Prior to disposal, recycling, or collection, all battery terminals must be securely insulated with a non conductive material to prevent any two batteries from short circuiting and generating heat during storage or transport. Battery terminals may be insulated with electrical tape; or batteries may be individually packaged in a non conductive material (e.g., plastic bag or original packaging).





20.4 Warranty

Warranty conditional on proper servicing as listed in 20.1 Service Checklist. Full details of the warranty are available in your Owners Opener Handbook, from your nearest B&D office or visit the B&D Website bnd.com.au.



21. Appendix

A - Status Indication during Operating Mode.

LEDs	Light Status				Indicates	
	BLUE	GREEN	YELLOW	RED		
DOOR OPEN AND CLOSED LEDS						
			solid			Open
			rapid flashing			Open with Autoclose timer running
		flashing			Opening / Obstructed on Open	
	solid				Closed	
	flashing				Closing / Obstructed on Close	
	flashing	flashing			Stopped	
	solid	solid			Partial Open	
MODE LED						
			flashing		Load Diagnostics mode	
REMOTE CONTROL STATUS LED						
			flashing		Remote lockout from vacation mode	
			rapid flashing		Remote Control Activity	

B - Adjustment Mode Instructions

STEP ONE

Remove controls cover



STEP TWO

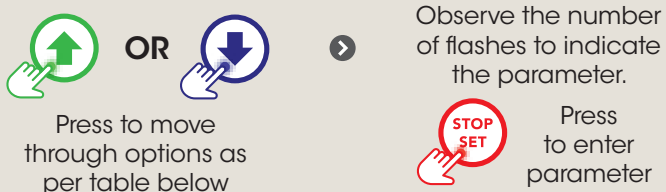

Parameter	x	Value options = Indicated by brightness of main light					
		1	2	3	4	5	6
MARGIN	x1	<u>1.0A</u>	1.2A	1.4A	1.6A	2.0A	-
PE AUTO-CLOSE	x2	<u>OFF</u>	15sec	30sec	60sec	90sec	-
AUTO-CLOSE	x3	<u>OFF</u>	15sec	30sec	60sec	90sec	120sec
LIGHTTIMER	x4	30sec	60sec	90sec	120sec	<u>180sec</u>	240sec
AUX OUTPUT	x5	Mimic light	<u>1sec</u>	30sec	60sec	120sec	180sec



tip When parameter edit mode is active, if any button other than MODE is pressed, then when MODE is pressed again, operating mode will be selected instead of the NETWORK adjustment mode.



tip **DEFAULT parameter (underlined)**

STEP THREE

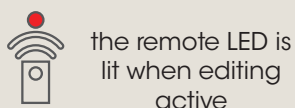

STEP FOUR

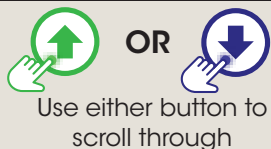

If no beep is heard, max or min setting is reached.

tip Pressing the MODE button when a parameter is being adjusted will load the default value.

STEP FIVE



LIGHT TIMER

- Adjusts the time the main light will remain on after the door is operated or a remote control code set to the Light remote control function is used.

AUX OUTPUT

- Configures how the AUX Output operates. If configured for Mimic light mode then the AUX output will activate whenever the main light output is on.
- All other settings require either a remote control code set to the AUX function or the Phone App to be used to activate the output.
- The time settings option indicates how long the output will remain on when triggered. If the output is already on, then a 2nd trigger will turn the output off.
- The toggle On/Off setting does not use a timer and the output simply changes state on each trigger..



C - Adjusting Force Margins

The Safety Obstruction Force is calculated automatically during setup. Adjusting this is normally only necessitated by environmental conditions such as windy or dusty areas, and areas with extreme temperature changes.

STEP ONE

Remove controls cover



Press repeatedly



till gear LED flashing

STEP TWO



Press together



remote LED is on and gear LED flashing

STEP THREE

STEP FOUR



Press to increase

OR



Press to decrease



Press to save



Press to exit

Light will dim or brighten

Then refit controls cover

D - Battery Functions

- a. Holding the STOP button for 10secs when running from battery backup will shut the PCB down so as to reduce battery current consumption to a minimum.
- b. Holding the STOP button for 4secs when a battery is fitted and running from mains power will cause the controller to test the battery state to determine if it is disconnected / open circuit, missing, faulty or ready.

E - Setting the PET mode position

STEP ONE

STEP TWO



HOLD

Close to desired position

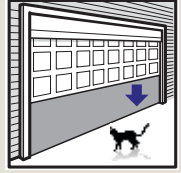



Press repeatedly



till gear LED lit

STEP THREE



Press to save



Opener will flash and beep



LED will light up

STEP FOUR

Refit controls cover









Press to exit

Proceed to Storing the transmitter Code to code a remote button to PET Mode



! tip When activated, PET mode drives the door to a preset position from the close position, therefore allowing a pet or parcel to go under the door.

F - Setting Limits via Transmitter



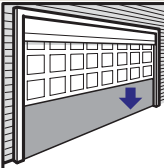

! tip The SPEED setting on the opener CAN NOT be adjusted when setting limits via the transmitter. Follow section 12.1 to set limits and adjust speed.



STEP ONE	STEP TWO
 Switch power on    BLUE LED will flash & gear LED lit	Remove controls cover    Press repeatedly till remote LED lit

STEP THREE	
    Then reft controls cover HOLD Opener flashes & beeps	HOLD for 3 sec RELEASE HOLD for 3 sec Release both buttons

CLOSE LIMIT POSITION	
STEP ONE   HOLD to Close Button 4 is factory coded to CLOSE function.	STEP TWO  When door near close, single presses inch door CLOSE limit should be when rubber strip touches the ground

! WARNING! In setting the close limit position, do not force the door into the floor with excessive force, as this can interfere with the ease of operation of the manual release mechanism.

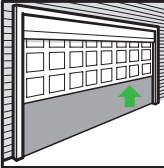
STEP THREE	
If door overshoots      Press to Open Press to Close position Button 2 is factory coded to SET function	Press to set

OPEN LIMIT POSITION	
STEP ONE   HOLD to Open Button 1 is factory coded to OPEN function.	STEP TWO  When door near open, single presses inch door OPEN limit should be the height of the garage opening

! WARNING! The door will automatically close. open and close again after the next step. Ensure that nothing is in the door's path.

STEP THREE	
If door overshoots      Press to Close Press to Open position Press to set	







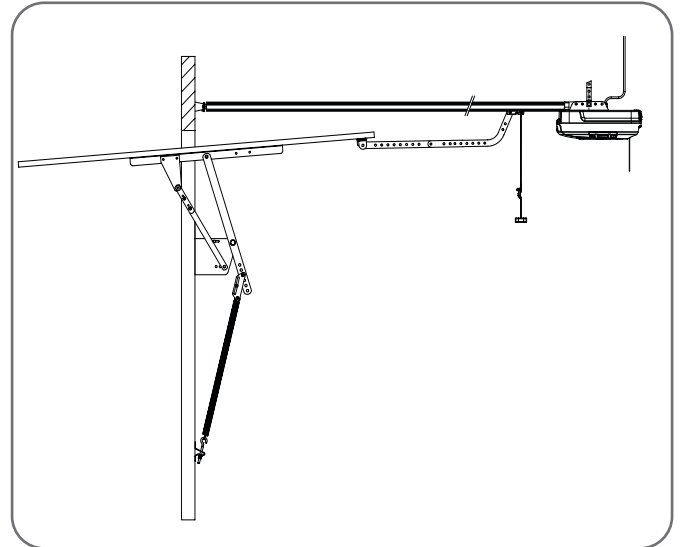
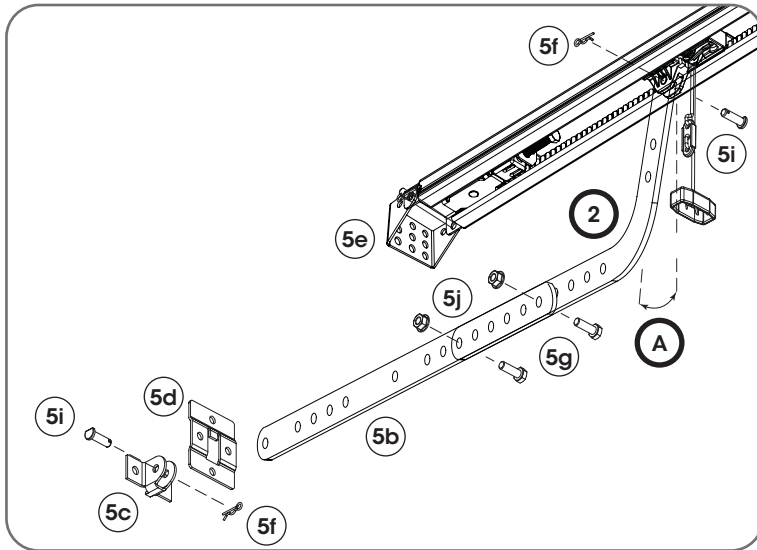



G - Setting up Tilt Door

tip If installing on a door with a bad wave action, lengthening the arm will assist in reducing this effect.



Prior to limit set up, the opener can be set to J-Type Tilt Profile. This process allows the opener to pre-set to J-Type settings where the limit is not greater than 1500mm.

tip In JTYPE Mode the drive speed is reduced and cannot be adjusted.

STEP ONE	
 <p>Switch power on</p>	 +  <p>BLUE LED will flash & gear LED lit</p>
STEP TWO	STEP THREE
<p>To activate JTYPE Mode</p>  +  <p>Press together and opener will beep TWICE</p>	<p>To return to Standard Mode</p>  +  <p>Press together and opener will beep ONCE</p>
STEP FOUR	
 OR  <p>To move the door to the halfway point.</p>	<p>Proceed to Setting Close Limit position.</p>

b&d doors office locations

Head Office	6-8 Fiveways Blvd, Keysborough 3073	Phone (03) 9791 2000
New South Wales	34 Marigold St, Revesby 2212	Phone (02) 9722 5555
Queensland	17 Oasis Court, Clontarf 4019	Phone (07) 3883 0200
Victoria	147-153 Canterbury Rd, Kilsyth 3137	Phone (03) 9237 7766
South Australia	23 Frederick Rd, Royal Park 5014	Phone (08) 8440 4747
Western Australia	96 Mulgool Rd, Malaga 6090	Phone (08) 9247 8777
International/Export	34 Marigold St, Revesby 2212	Phone +61 (0)2 9722 5555

your representative is

Prefixed trademarks are the property of B&D Australia Pty Ltd. B&D Doors & Openers is a division of B&D Australia Pty Ltd. ABN 25 010 473 971. © 2018 B&D Australia Pty Ltd.

www.bnd.com.au

