

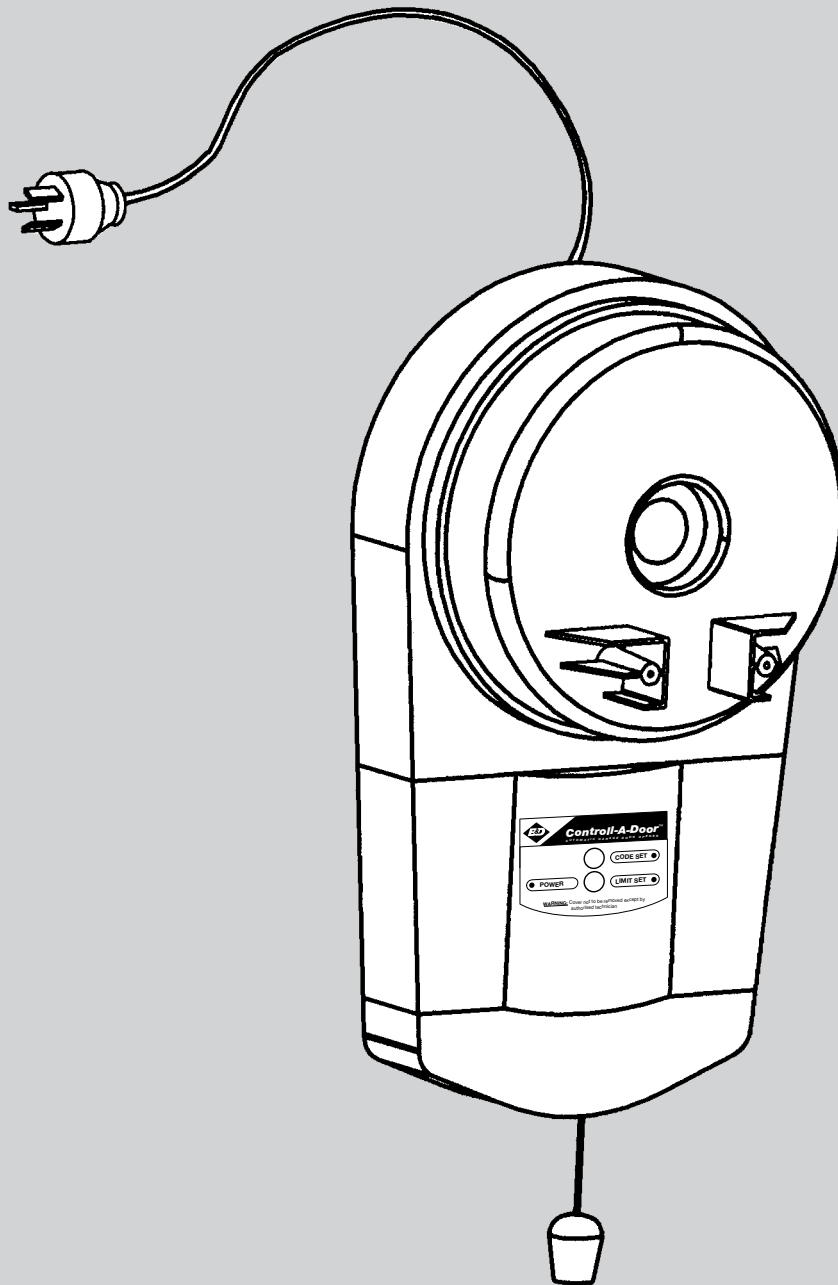

Controll-A-Door® 5

Automatic Rolling Garage Door Opener



Quality
Endorsed
Company
ISO9002



N1134

Instruction Manual

START BY READING THESE IMPORTANT SAFETY RULES



These safety alert symbols mean **Caution** – a personal safety or property damage instruction. Read these instructions carefully.
This Automatic Garage Door Opener is designed and tested to offer safe service provided it is installed and operated in strict accordance with the following safety rules.
Failure to comply with the following instructions may result in serious personal injury or property damage.

Caution: If your garage has no service entrance door, an emergency access device can be installed. This accessory allows manual operation of the garage door from outside in case of power failure.



This opener should be installed in accordance with relevant Australian Standards.



Do not allow children to play with door controls (AS3350).



Keep remote controls away from children (AS3350).



Watch the moving door and keep people away until the door is completely opened or closed (AS3350).



Activate the opener only when the door is in full view, free of obstructions and with the opener properly adjusted.



Keep garage door balanced. Sticking or binding doors must be repaired. Garage doors, door springs, brackets and their hardware are under extreme tension and can cause serious personal injury. ***Do not attempt any adjustment. Do not use if repair or adjustment is needed.***
Call for professional garage door service.



Install optional door control button in a location where the garage door is visible, but out of the reach of children at a height of at least 1.5m (AS3350).



Do not wear rings, watches or loose clothing while installing or servicing a garage door opener.



This opener is not suitable for commercial, industrial or common entry applications.



To avoid serious personal injury from entanglement, remove all unnecessary ropes or chains and disable any equipment such as locks which are not needed for powered operation (AS3350).



Installation and wiring must be in compliance with your local building and electrical codes. ***Connect the power cord only to properly earthed mains.*** If an extension lead is used, make sure it is a 3 core lead and approved to 5 amp capacity.



If the supply cord is damaged, it must be replaced by the manufacturer or its service agent or a similar qualified person in order to avoid hazard.



Do not use the force adjustments to compensate for a binding or sticking garage door. Excessive force will interfere with the proper operation of the Safety Reverse System or damage the garage door.



Disconnect electric power to the garage door opener before removing covers.



When using optional auto close mode, a B&D safety infrared beam must be fitted correctly and tested for operation at regular intervals. Extreme caution is recommended when using auto close mode. All safety rules must be followed.



This opener is a 240 volt appliance and must be installed in a dry position that is protected from the weather.



The opener is not intended for use by young children or infirm persons without supervision.



A properly earthed, 3 pin, 240 volt power supply is required.

WARNING! A portable power generator is not recommended. The opener may appear to malfunction due to spikes, surges and fluctuations in the generated voltage.

CONTENTS

Safety Rules	p. 2
Contents	p. 3
About your B&D Controll-A-Door 5 Unit	p. 4
Specifications	p. 4
Accessories	p. 5
Section 1 Requirements	
Door Operation.....	p. 6
Position	p. 6
Power Supply	p. 6
Sideroom.....	p. 6
What you may need.....	p. 7
Section 2 General Arrangement.....	p. 7
Items Supplied in the carton.....	p. 7
Section 3 Installation Procedures	
Preparation	p. 8
Fit Weight Bar.....	p. 8
Pin the Door Curtain	p. 9
Fit the Opener.....	p. 9
Program The Opener	p. 10
Setting Dip Switches	p. 10
Door Travel Limit Setting	p. 11
Remote Control Transmitter Code Setting	p. 12
Setting Remote Control Transmitter Dip Switch Codes	p. 12
To Erase Programmed Codes.....	p. 12
Safety System	p. 12
Testing the Safety System	p. 13
Section 4 Fitting Accessory Items	
Fitting Wired Accessories.....	p. 14
Section 5 How To Operate	p. 14
Remote Control Transmitter.....	p. 15
Inbuilt Locking Facility	p. 15
Manual Operation.....	p. 16
Power Failure	p. 16
Safety Infra Red Beam Option	p. 16
Auto Close Option	p. 16
Remote Control Transmitter Battery	p. 16
Changing a Light Globe	p. 17
Service Call	p. 17
Maintenance	p. 17
Section 6 Diagnostic Codes	p. 19
Section 7 Save a Service Call	p. 21
Section 8 Warranty	p. 22

Should you have any queries or require assistance with your Controll-A-Door opener, contact your local B&D Dealer or contact the B&D office in your capital city. See back page of this handbook for contact details.

IMPORTANT SAFETY INSTRUCTIONS

WARNING - It is vital for the safety of persons to follow all instructions.

SAVE THESE INSTRUCTIONS

AS3350

ABOUT YOUR B&D CONTROLL-A-DOOR® 5 OPENER

Thank you for choosing B&D's Controll-A-Door® 5. This automatic garage door opener has been designed and developed in Australia by B&D Automatic Access Systems - an Australian Owned company - to suit local conditions.

The technically advanced construction of this B&D Controll-A-Door® 5 opener ensures you enjoy the following benefits:

- 5 year full parts and labour warranty on motor, electronics and mechanical components of the opener (Conditions Apply).
- Your own private security code with 3.486 billion available codes, meaning only you can open your garage door. Allows you to electronically program your security code at the touch of a button.
- Standard 3 channel remote control transmitter allows you to operate an adjoining garage door or entry gate if automated
- Automatic safety reverse should the door be obstructed while closing.
- Courtesy light automatically switches on for approximately 4½ minutes when operating the door.
- Emergency release handle for manual operation of the door in the event of a power failure.
- Automatic resetting of all codes and limits after a power failure.
- No need to manually lock your garage door, as Controll-A-Door® 5 'positively' locks the door when closed.
- Adjustable safety reversing settings to compensate for changes in door characteristics.
- Auto closing option can be programmed to close the door approximately 30 seconds after the door has opened.
N.B. Safety Infra Red Beams must be installed if this option is chosen
- Flashing LED's to easily identify operational problems or service requirements.
- Compatible with a wide range of B & D Controll-A-Door® Accessories.

SPECIFICATIONS

Maximum Door Size and Door Load	3000mm high Residential Rolling Garage Door or 2400mm high Wind Lock Residential Rolling Garage Door that does not exceed 200N (20kgs) bottom rail load
Supply Voltage	220 – 240 volts AC – 50 Hz only
Current	Maximum 3.5 Amps
Lamp	One 25 watt, Pilot Lamp, on when door starts, off approx. 4 ½ minutes later
Limit Adjustment	Electronic
Remote Control Transmitter Frequency	433.92 MHz
Rated Load	250N AS3350

ACCESSORIES

B&D has a range of additional accessories for your added convenience and security.

- **Safety Infra Red Beams.** Gives additional protection if the door is closing onto your property or person. Simply breaking the beam “stops” the door! Must be fitted if autoclosing feature is operational - Part No 62153.
- **Keyring remote control transmitter.** Ideal for personal use when entry into the house may be via the garage – Part No 62162.
- **Entry Keypad.** Key in your own 4 digit PIN (Personal Identification Number). Allows you to open the garage without taking a key or remote control remote control transmitter with you. Ideal for children or when out jogging (no need to hide a key!) – Part No 62173.
- **Remote control transmitter Wall Button.** Allows you to operate the opener within 10 metres of the door. Ideal for mounting inside the house – Part No 62163.
- **Remote Control Transmitter 3 Channel 433MHz.** Get a spare remote control transmitter for your second car or mount it inside the house for convenient operation of your garage door – Part No 62170.
- **Combo Access Kit.** Keyswitch function will open the door without a remote control transmitter. Can be used to manually disengage the opener, recommended when the garage door is the only access to the garage – Part No 59009.

Also available for your convenience is the B&D Controll-A-Gate® automatic gate opener. With models to suit swing and slide gates for residential applications. Most of your Accessories are compatible with Controll-A-Gate®.

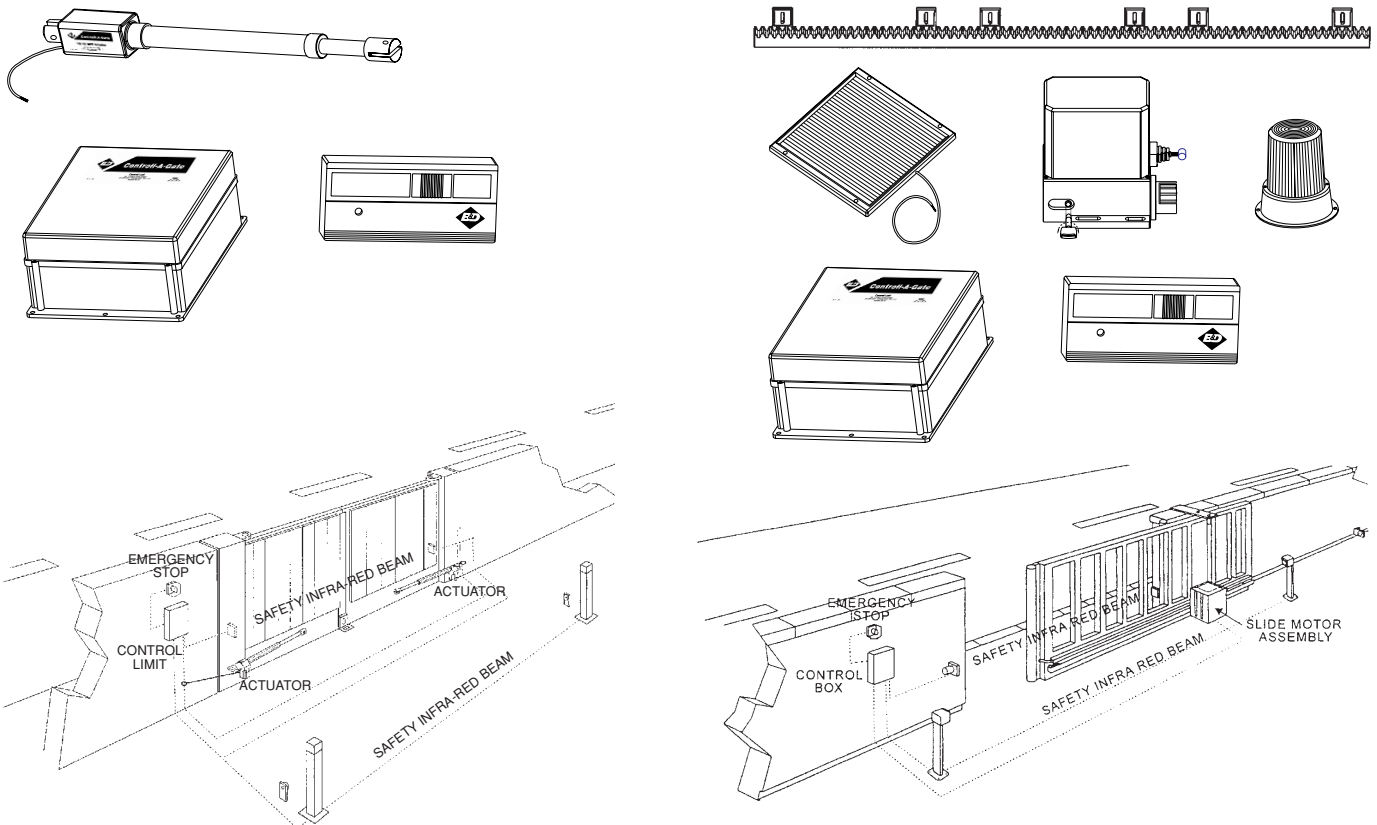

Contact your authorised B&D dealer for installation of these accessory items.

SECTION 1 - REQUIREMENTS

IMPORTANT SAFETY INSTRUCTIONS FOR INSTALLATION
WARNING - INCORRECT INSTALLATION CAN LEAD TO SEVERE INJURY.
FOLLOW ALL INSTALLATION INSTRUCTIONS.

AS3350

DOOR OPERATION

The door must be in good operating condition and the maximum effort to move the door up or down, from stationary, should not exceed 200 Newton's (20kg force) at the bottom rail. The door may need to be serviced to meet this requirement - refer to door manufacturers servicing instructions



Before installing the opener, check that the door is in good mechanical condition and correctly balanced and that it opens and closes properly.

AS3350

Note: *The fitting of an opener to doors with removable mullions is not recommended.*

POSITION

It is recommended that the opener be installed on the right hand side of the door, however the opener can be installed on either the right hand or left hand side of the door (viewed from inside the garage looking out - left is left). The opener must be mounted in a dry position that is protected from the weather. The B&D Controll-A-Door 5[®] is not designed for external use. Moisture or corrosion may damage the opener and this is not covered by the Warranty. Do not allow water, or other liquids, to enter the opener or remote control transmitter.

POWER SUPPLY



A properly earthed, 3 pin, 240 volt power supply is required.

WARNING! A portable power generator is not recommended. The opener may appear to malfunction due to spikes, surges and fluctuations in the generated voltage.

SIDEROOM

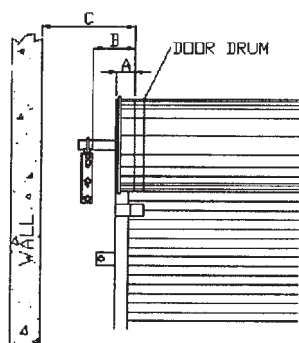

Dimension A = 75mm maximum. This is the distance from the door drum to the edge of the door curtain/door guide. If dimension A is greater than 75mm, a ring gear adaptor (Part No 59585) will be required.

Dimension B = 120mm minimum to 135mm maximum. This is the distance from the door drum to the inside of the door bracket.

Dimension C = 165mm minimum. This is the distance from the door drum to the garage wall.

Note:

- 1 The door bracket may have to be relocated to line up with the slots in the mounting bracket of the opener (the opener may be mounted onto the axle - see Fit The Opener for special instructions).
- 2 The chassis **must not** be cut down to reduce sideroom - the warranty is invalidated if this occurs.
- 3 These dimensions assume the opener will be fitted while the door is on the floor. If the door is already installed an additional 150mm clearance is required to slide the opener over the axle.

WHAT YOU MAY NEED TO DO THE JOB

- Suitable door support (eg. a ladder)
- Phillips screwdriver
- Suitable sockets and handle with a 150mm extension
- 450mm pipe wrench (Stillson) or similar
- Adjustable wrench or spanner set
- Marking pencil
- Tape measure
- Drill
- 4.5mm drill bit for mounting weight bar
- 3.2mm drill bit for pinning door curtain
- length of rope

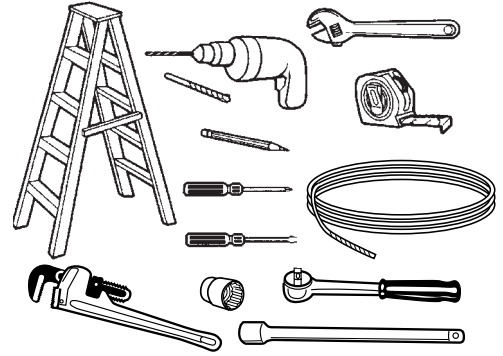

SECTION 2 – GENERAL ARRANGEMENT

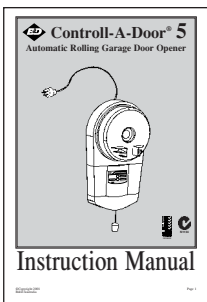

1. Instruction Manual

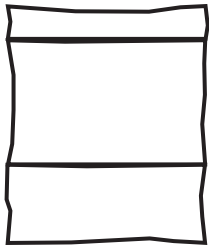

4. Hardware Bag

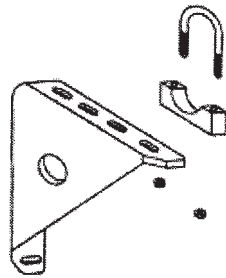

2. Powerhead

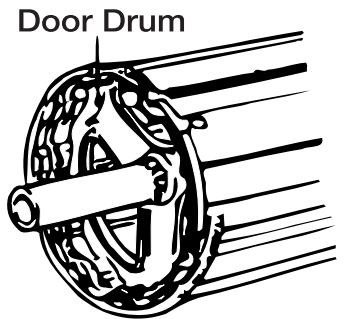
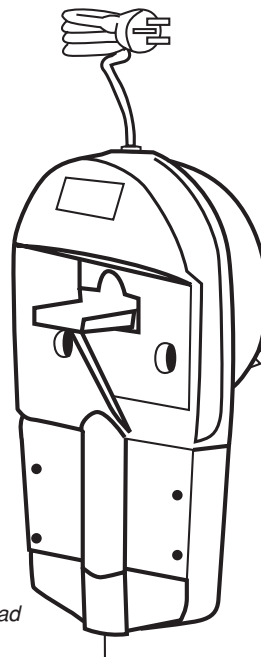

3. Weightbar

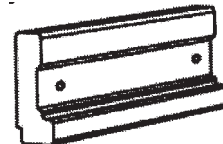

Items supplied in the carton:

1. Instruction Manual
2. Powerhead
3. Weightbar
4. Hardware package containing:
 - a. Qty 1 Axle to bracket clamp
 - b. Qty 2 nut whiz 5/16 UNC
 - c. Qty 1 Bolt U 5/16 x 2 1/2
 - d. Qty 2 Screw M4 x 50
 - e. Qty 2 Nut M4 Hex
 - f. Qty 2 5/32 shakeproof washer
 - g. Qty 2 3/16x1/2 flat washers
 - h. Qty 2 locking bar covers
 - i. Qty 2 washer 6.4x20.6x1.2 to pin the door curtain
 - j. Qty 2 Screw 10x32 Self Tapping
 - k. Qty 1 Cable Clip
 - l. Qty 1 Transmitter with visor clip

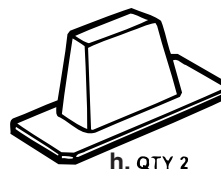

h. QTY 2

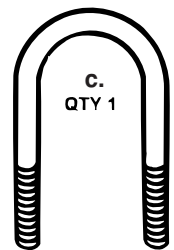

c. QTY 1



a. QTY 1



b. QTY 2



d. QTY 2

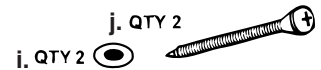

j. QTY 2



e. QTY 2

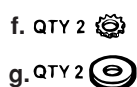

f. QTY 2

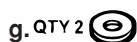

g. QTY 2

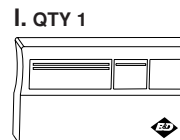

l. QTY 1



k. QTY 1

SECTION 3 – INSTALLATION PROCEDURES

The following is the preferred method of installing the opener

Step 1: Preparation

- a. Check the door operation.
 - i. The door must be smooth to operate by hand.
 - ii. Operating force on the bottom rail must not exceed 200 Newton's (20kg) force.
 - iii. Adjust the guides if they are tight or replace if they are twisted.
 - iv. Clean the guides if there is any oil or wax present.
- b. Install locking bar covers if there are locking bar holes in the guides

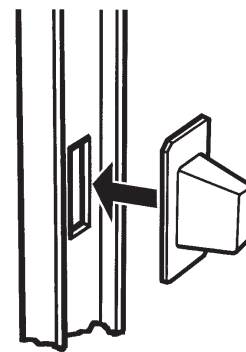

Note: *DO NOT lock your door with the locking bars after installing your opener. Locks should be disabled (recommend the use of tie wire or cable ties). This will not affect the ability of your door to lock as the opener has an inbuilt locking facility.*

- c. Choose the end where you will install the opener and ensure there is sufficient sideroom. (Refer to sideroom requirement).
- d. Warning labels supplied with this opener should be fitted as appropriate.

Step 2: FIT WEIGHT BAR

The weight bar must be fitted to the bottom-centre of the door as follows:

If the door has a handle:

- Remove the door handle, and
- Fit the weight bar and refit the handle using the new fasteners provided

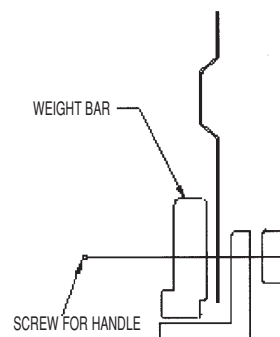

If the door does not have a handle:

- measure in from both sides of the door to find the centre of the door at the bottom
- place the weight bar at this point (there is a centerline marked on the weight bar) and mark the two positions where the fasteners will go.
- Drill the two 4.5mm holes in the door and fit the weight bar using the new fasteners provided.
- Cut excess screw length if protruding past door rail.

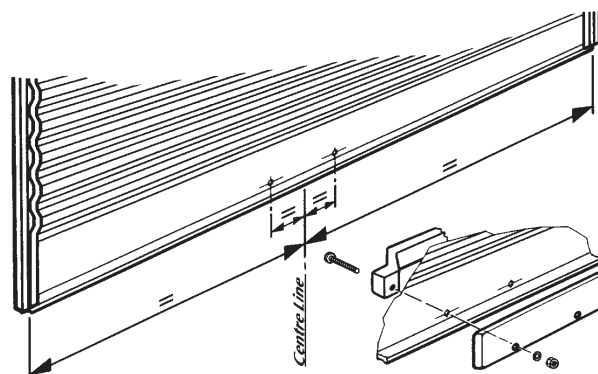

Check that the door is balanced and smooth to operate. If it is not then the door may require servicing (refer to door manufacturers instructions).



The door is held under significant tension. Adjustments should only be carried out by experienced persons, as this function can be dangerous if not performed under strict safety procedures.

Step 3: PIN THE DOOR CURTAIN

Pin the door curtain to the door drum at each end of the door to maintain security when the opener closes and locks. With the door fully closed:

- Mark positions to drill in both drums as shown.
- Open door slightly to get access to these positions.
- Drill using 3.2mm (1/8") drill.
- Fit a No 10 x 32mm screw and washer to each drum. While this screw should be positioned as low as possible, make sure that it does not alter the normal curtain to guide approach.
- Make sure that the screws do not project into the area where the ring gear will fit.

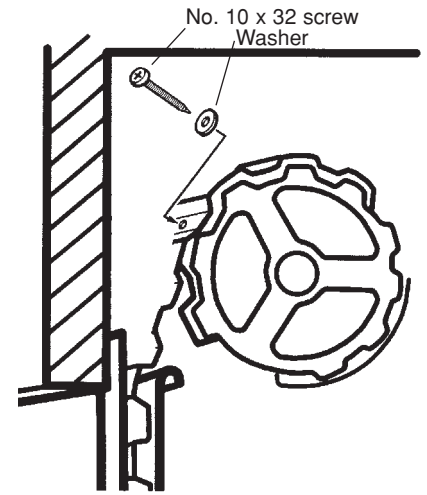

Step 4: FIT THE OPENER

- Choose whether the opener is to be fitted right hand or left hand (refer to Position and Sideroom) - right hand fitting is recommended where possible.
- At the end opposite to where the opener will be fitted, check to make sure the "U" bolt is tightened securely.
- Open the door completely and tie 2 safety ropes around the door roll approximately 300mm from each end (not too tight) as a safety precaution.
- At the end where the opener is to be fitted, support the door. It is recommended that you support the door with either:
 - a sling or a block and tackle from above the door, or
 - a suitable stand e.g. a ladder and blocks (see illustration). If you use blocks make sure they are flat on the top of the ladder and that they are wide enough to take the weight of the door without damaging it.

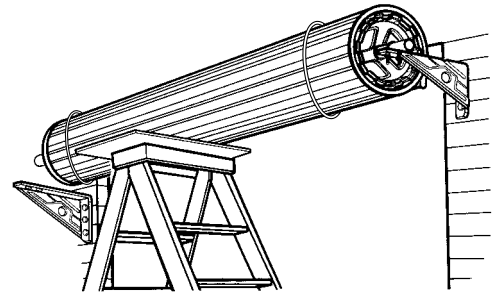

Warning - make sure the support is snug under the door and that both the support and door are stable and will not move.

- Mark the position of the "U" bolt in the door bracket and the position of the door bracket on the wall to assist when reassembling.
- Remove the "U" bolt (or bolts) and saddle from the door bracket at the end where the opener is to be fitted. Remove this door bracket allowing the door to rest on the support (see illustration). Note: For poor sideroom installations the door may have to be taken down.

- Fit the opener as follows:

- Disengage the opener by pulling the disengagement handle down (there will be an audible click), so that the ring gear can be rotated by hand.
- Slide the opener over the door axle and into the drum of the door. Ensure the ring gear is pushed in as far as possible (without interfering with the door curtain) so that the drive finger completely engages one of the door drum wheel spokes.

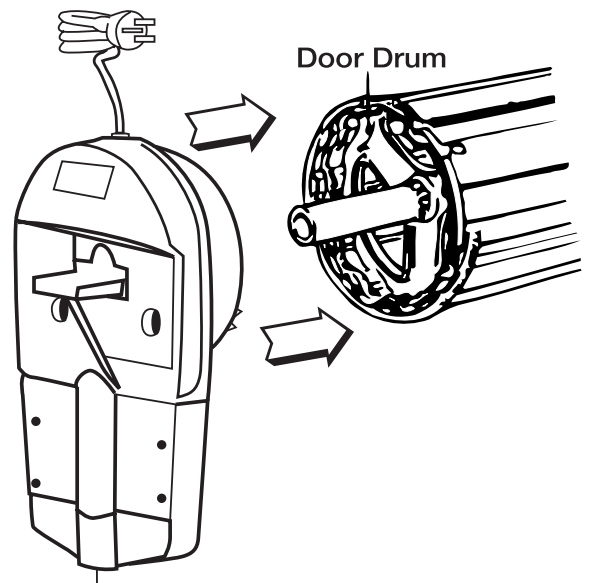

8. Re-attach the door bracket using your reference marks as a guide and tighten the bolts. Ensure that the slots in the mounting bracket of the opener align with the slots in the door bracket - the door bracket may have to be relocated.

Note: If the bracket cannot be relocated, the opener may be fitted onto the axle as follows:

- For Series 1 style doors - you will need to use two Series 1 style, 5/16" U bolts and saddles (one set supplied) to attach the operator to the axle, or
 - For Series 2 style doors - you will need to use the Series 2 style, 3/8" U bolt and cast saddle (not supplied) to attach the operator to the axle.
9. Using your reference marks as a guide:
 - For Series 1 style doors - fit the new U bolt and saddle with the 2 nuts supplied and tighten firmly, or
 - For Series 2 style doors - reuse the existing bolt and saddle arrangement. Note: the Series 2 style cast saddle will need to have 1mm ground off both sides to fit into the operator mounting bracket.
 10. Adjust the door position (if necessary) on the brackets so that the door feeds smoothly into the guides. Make sure that the center of the door doesn't hit the lintel and that the curtain is not pushed forward hard into the guide.
 11. Remove the support and safety ropes.

	<p style="text-align: center;">If the manual release is more than 1.8 metres from floor level when the opener is installed, extend the manual release handle to a height less than 1.8 metres.</p> <p style="text-align: right;">AS3350</p>
---	--

12. Connect the power cord to a suitable power point - do not switch on. Secure the cord away from any moving object (e.g. the door roll) with the cable clip supplied.
13. Pull the door up and down to make sure it runs freely - make sure the ring gear is still disengaged.

Step 5: PROGRAM THE OPENER

The opener needs to have the dipswitches, force settings, door travel limits and remote control transmitter codes programmed before it is fully operational. The following method of programming is recommended. Remove the 2 screws retaining the light cover, the light cover can hang on the disengagement handle. (the screws are captive and should remain in the light cover).

Step 6: Setting DipSwitches.

There are 4 dipswitches located at the base of the opener that need to be set **before power is turned on**, as follows:

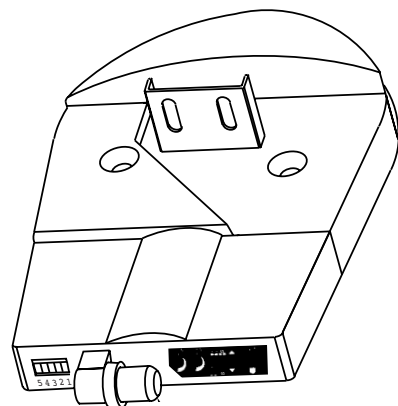
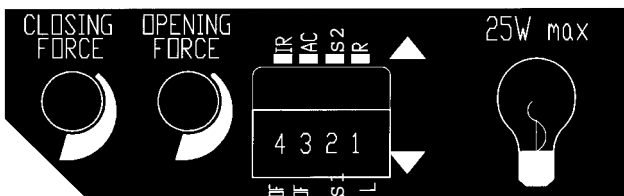

- **Switch 1: R or L.** This switch selects which side of the door the opener is to be installed on -L for Left Hand, R for Right Hand. Changing the Left-Right switch will cause all previously programmed limits to be erased. The power to the opener must be turned off then on again whenever this switch is updated.
- **Switch 2: S1 or S2.** This switch changes the sensitivity of the obstruction sensing system. If the door is a small Series 1 door in good condition set the switch to S1, for larger doors like Series 2 doors set the switch to S2.
- **Switch 3: AC - OFF.** This switch enables the autoclose feature. An IR Beam must be fitted and enabled for this feature to work. When autoclose is selected the door will close automatically 30 seconds after opening. The door will attempt to close up to 4 times (for 2 minutes) if repeatedly prevented by obstructions.
- **Switch 4: IR - OFF.** This switch enables a remote infra red beam accessory to be fitted. When "On" an IR Beam accessory must be fitted and functional. If an IR Beam is not operating then the door, once opened, cannot be closed. The relays will click twice when the operate button is pressed to indicate this condition. When an IR Beam is selected and functioning correctly the door will cease closing (or refuse to close) when the beam is obstructed. When off (normal operation) any IR Beam accessory will be ignored and the autoclose feature disabled (even if selected).

Step 7: Door Travel Limit Setting.

Limits must be programmed for the desired range of movement of the door as follows:

- Turn on the power to the opener, the CODE SET and LIMIT SET lights will flash rapidly for a few seconds whilst the opener goes through a diagnostic self-test, then the POWER LED will illuminate.
- The operator should still be disengaged, if not, disengage the opener by pulling down the handle.

	<p>Use caution when operating the manual release with the door open since it may fall rapidly due to weak or broken springs, or an imbalanced door AS3350</p> <p>Caution: Do not disengage the opener to manual operation with children/persons or any objects including motor vehicles within the doorway.</p>
---	---

- Manually move the door to a position half way between the open and closed positions.
- Press the LIMIT SET button until the Limit Set LED illuminates (approx. 3 seconds).
- Move the door to the desired lower limit and press the LIMIT SET button to accept this bottom limit. The Limit Set LED will now be flashing.
- Move the door to the desired upper limit and press the LIMIT SET button to accept this limit. The flashing LED will go out.
- Re-engage the opener by pulling down on the handle.
- Hold the light cover in place and press the operate button to ensure that the door closes and opens properly.

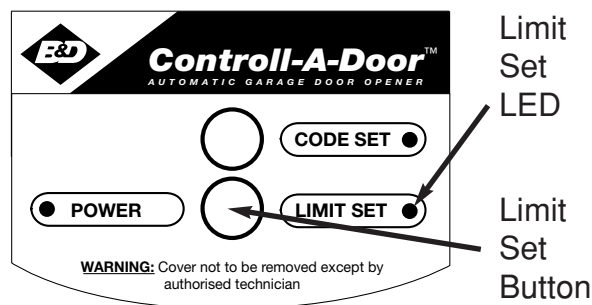

NB: Limit setting can also be set using the operate button on the opener. Start with the door engaged in the half way position. Press the LIMIT SET button until the Limit Set LED illuminates (approx. 3 seconds). Press the Operate button until the door is in the bottom setting position and press LIMIT SET. Press the Operate button for the door to move to the top setting, press LIMIT SET. The limits are now set.

Step 8: Remote Control Transmitter Code Setting.

The receiver needs to learn the codes of any remote control device that will be used with the operator. The receiver has storage for 14 memory codes and can store:

- Up to 12 remote control transmitters. After 12 codes have been stored, any additional code stored will cause the oldest code to be erased.
- One dip-switch remote control transmitter code, and
- One entry keypad code.

Note: Programming a different dip-switch code or entry keypad will automatically erase any previously programmed code.

All remote control transmitter codes are learned using one of the following procedures:

Procedure 1:

- Ensure the Power LED is ON.
- Press and hold the remote control transmitter button to be programmed. For an entry keypad the desired code should be typed (a minimum of four numbers or letters) and the ENTER button held down.
- Press and release the Code Set button.
- The Code Set LED will start flashing to indicate that the code has been learnt, but the door will not move.
- Release the button on the remote control transmitter.

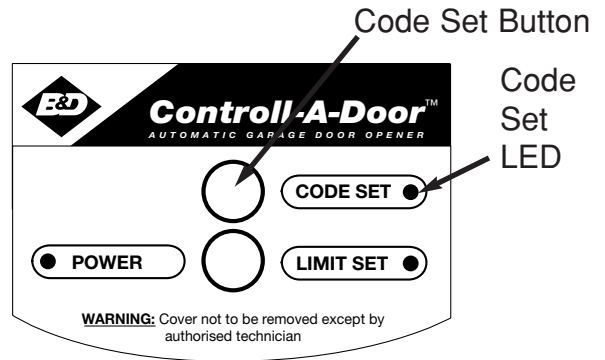

Procedure 2:

- Ensure the Power LED is ON.
- Press the Code Set button on the opener, the Code Set LED will illuminate.
- Press and hold the remote control transmitter button to be programmed. For an entry keypad the desired code should be typed (a minimum of four numbers or letters) and the ENTER button held down.
- The Code Set LED will start flashing to indicate that the code has been learnt, but the door will not move.
- Release the button on the remote control transmitter.

Note:

1. If you release the remote control transmitter button before the CODE SET LED flashes, the opener has not learned the code.
2. Additional remote control transmitters can be programmed by repeating the above steps.

Step 9: SETTING REMOTE CONTROL TRANSMITTER DIPSWITCH CODES.

Some remote control transmitters have a dip-switch facility. Generally, dipswitches are used when several persons are operating the same opener. The dip-switches must be set to matching positions in all remotes used to activate the opener.

- Remove the battery cover.
- Set switches in all remote controls to matching positions (+, -, 0). Use a pen or screwdriver.
- Replace covers and program this code, using the methods in procedure 1 or 2.

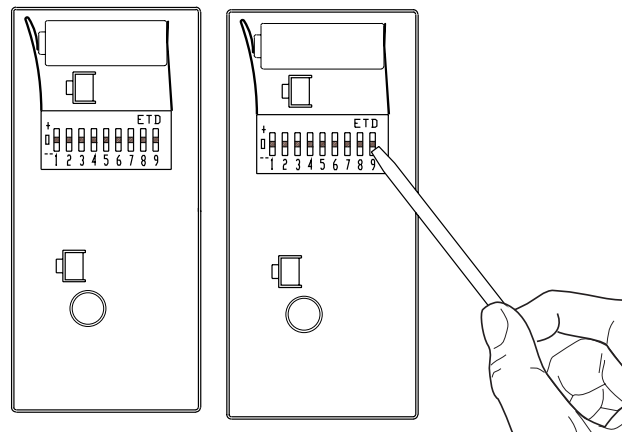

Install any fixed control (eg keypad, key switch or wall button) within sight of the door but away from moving parts and at a height of at least 1.5 metres.

AS3350

Step 10: TO ERASE PROGRAMMED CODES.

If the Code Set button is pressed and held on for 6 seconds, the LED will blink rapidly for one second to indicate that all programmed codes have been erased.

Step 11: SAFETY SYSTEM.

It is extremely important that the safety system is set up correctly and that the system be tested/adjusted on a regular basis. The force should be sufficient to move the door during normal operation but not excessively high to prevent the safety system activating in the case of a collision. The opening and closing force adjustments are the same for left-hand and right-hand installation. The system should be set up as follows:

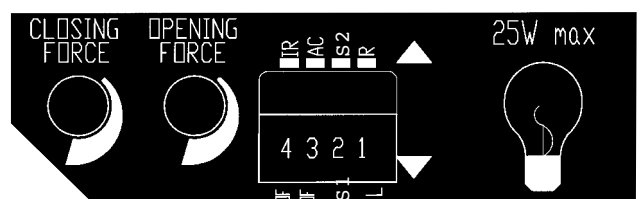

Closing Force

- a. The door should be in the open position with power on.
- b. Set the closing force adjuster initially to the minimum position.
- c. Press the remote control transmitter (or whilst holding the light cover in place, press the operate button) to start the door moving down. If the door reverses whilst closing (or does not move at all), increase the closing force adjuster (turn the closing force adjuster clockwise) in small increments until the door closes properly (Alternatively, for large doors you may set the closing force adjuster to the mid position and whilst the door is moving down, decrease the closing force (slowly turning the closing adjuster anti clockwise) until the door reverses.
Note: You may need to repeat steps a to c.
- d. Once you have completed step c., increase (turn clockwise) the closing force adjuster by 1/8th of a turn
- e. Operate the door to ensure that it closes without reversing.

Opening Force

- f. Set the opening force adjuster to the mid position.
- g. With the door in the closed position, operate the opener to open the door. Whilst the door is opening, decrease the opening force (turn the opening force adjuster anti-clockwise) until the door halts (the Code Set and Limit Set LED's will flash to indicate a collision error).
- h. Clear the flashing LED's by holding the light cover in place and press the operate button, the flashing LED's will stop flashing.
Note: - you may need to repeat steps g and h.
- i. Increase the opening force adjuster (turn the opening force adjuster clockwise) by 1/4 of a turn.
- j. Operate the door to ensure that it opens without halting.

Test

- k. Test the Safety Reversing System and make any adjustments as necessary.
- l. Refit the light cover and press the operate button to ensure the door opens and closes properly.

	<p>Permanently fix the label warning against entrapment and manual operation in a prominent place or near any fixed controls. After installation, ensure that the mechanism is properly adjusted and that the opener reverses when the door contacts a 40mm high object placed on the floor under the garage door.</p> <p style="text-align: right;">AS3350</p>
---	--

Step 12: TESTING THE SAFETY SYSTEM

The operation of the Safety System must be tested whenever there has been any change in settings, or adjustment to the door and tested monthly during the operational life of the opener. To test the safety system the following procedure should be used.

Door Closing Test

- Ensure that the door is open.
- Place a 40mm obstacle laid flat on the floor under the garage door.
- Operate the door in the down direction, the door must reverse on hitting the obstruction.
- If the door fails to reverse, or stops on the obstruction, the down force will have to be decreased.
- Remove the obstacle and run the opener through a complete travel cycle.

Door Opening Test

- Ensure that the door is closed.
- Operate the opener to open the door.
- While the door is opening (approximately 1 metre off the floor) hold the bottom edge of the door with your hand. When a moderate downward force (100 Newton's/10kg) is exerted, the door should halt.
- This will cause the LED's to start flashing to indicate an error.
- Clear the collision error by pressing the operate button, the LED's will stop flashing.
- If the door fails to halt the up force will have to be decreased (see above).

Check to make sure the door opens and closes properly.

	<p>The safety system is designed to prevent entrapment or serious injury. It relies upon physical contact with objects in the path of the door. The safety system alone may not prevent cosmetic damage to motor vehicles or property.</p>
---	---

SECTION 4 – FITTING ACCESSORY ITEM

Wired Accessories

A variety of accessory items can be fitted to the opener (eg Safety Infra Red Beam or a wall switch). In order to connect any accessory a standard Plug-in 8A 5.08mm Pitch x 5 PCB Mounting Terminal Block will need to be fitted to the outlet of the Printed Circuit Board. To install this connector you will need to remove the light cover and using a suitable tool, remove the breakout on the cover to allow the wiring to pass through to the opener.

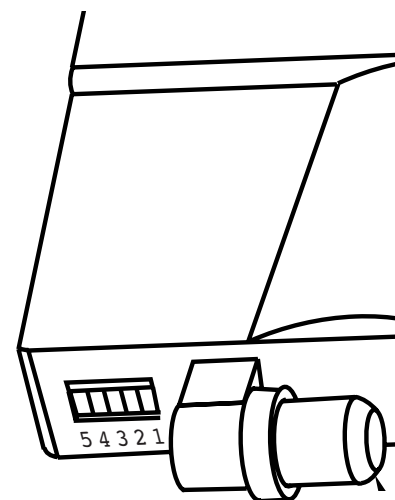

This connector is available from B&D as follows:

Part No 59689 Terminal Connector Qty 1
 Part No 59690 Terminal Connector Qty 10

Once the plug has been fitted, wiring of accessory items is as follows:

PIN	NAME	DESCRIPTION
1	Ground (-Ve)	Common ground terminal (-Ve) used by all accessories
2	Safety IR Beam	To connect the Safety Infra Red Beam (Part No 62153) sensors: Connect both white wires to Pin No 1 (Ground terminal). Connect both white with black stripe wires to Pin No 2. The nominal output voltage is 5.5V with a capacity of 50mA before shutdown to Low Power mode.
3	Power (+Ve)	Power output for external receiver or other powered accessory - Voltage 12-17 VDC. Maximum continuous current capacity 100mA. This output is protected against short circuit by a 200mA polyfuse.
4	Door Travel Limit Setting	A normally open, momentary push button can be connected between this terminal and Ground (Pin No 1) to provide a remote Limit Set switch as an alternative to the limit setting described in Step 7.
5	Remote Operate	A normally open, momentary push button can be connected between this terminal and Ground (Pin No 1) to provide a remote Operate switch. This switch may be illuminated with an LED as this pin has an integral 560 ohm pull-up to +Ve (i.e. 19mA @ 1.5v).

Note: Any pin may be shorted to any other pin or ground without damaging the opener. Whilst the short circuit exists the opener will fail to operate. This feature protects against damage caused by shorts in external accessory wiring.

	<p>When installing Accessories, always follow the manufacturer's instructions included with the product.</p>
--	---

SECTION 5 - HOW TO OPERATE

For maximum efficiency of your opener, your garage door must be in good operating condition. A regular service of the door by an authorised B&D dealer is recommended.

	<ul style="list-style-type: none">• Activate the opener only when the door is in full view, free of obstructions and with the opener properly adjusted. No one should enter or leave the garage while the door is in motion. Do not allow children to play near the door.• This opener is a 240 volt appliance and there are no user serviceable parts inside this opener
---	--

Remote Control Transmitter 3 Channel

To use the remote control transmitter:

- Press the programmed button of the remote control transmitter until your door begins to move (usually 2 seconds) to open or close the door. Make sure you can see the door when you use the remote control transmitter.

If you are in a vehicle you should aim the remote control transmitter through your windscreen. You may attach your remote control transmitter to your visor with the clip provided, it should be secured so that when the remote control transmitter is operated it is transmitting through the vehicle windscreen.

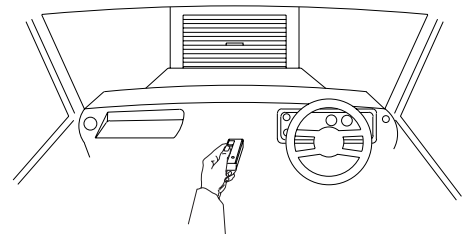

- Check that the door is fully closed before you drive away.
- If you press the remote control transmitter whilst the door is moving:
 - i. Downwards – the door will stop and then reverse to the open position.
 - ii. Upwards – the door will stop, with the next press of the remote control transmitter the door will move downwards.

Note: Once the door is moving, the operating distance of the remote control transmitter is significantly less than when the door is stationary.

Additional remote control transmitters may be purchased at any time.

Operate Button.

Incorporated in the light cover is an operate button. Pressing this button will operate the door, the same as the remote control transmitter as described above.

If the LEDs are flashing a diagnostic code, pressing this button will reset the opener and stop the flashing LEDs.

Inbuilt Locking Facility

DO NOT lock your door with the locking bars when your opener is engaged. This opener has an inbuilt locking facility. With the opener engaged your door will be locked whether the power is on or off.

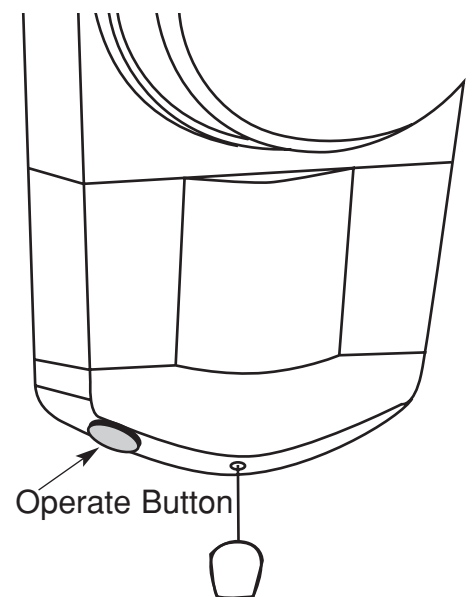

Manual Operation



Use caution when operating the manual release with the door open since it may fall rapidly due to weak or broken springs, or an imbalanced door. AS3350

Caution: Do not disengage the opener to manual operation with children/persons or any objects including motor vehicles within the doorway.

To disengage the opener from the door, (preferably with the door in the closed position) pull down on the disengagement handle - you will hear a 'click'. Pulling down on this handle again (click) will re-engage the opener, i.e. automatic operation.

You may manually open or close the door any time without affecting the pre-set limits.

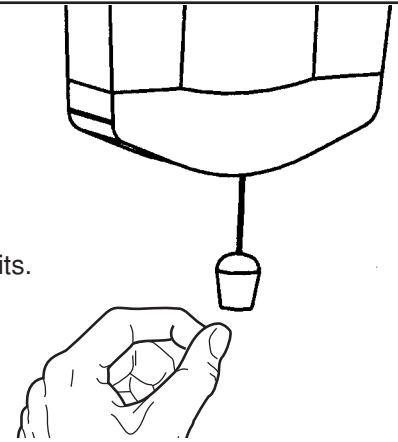

Warning: When the opener is manually disengaged, the door is no longer locked. When the door is closed you should either :
a. Re-engage the opener, or
b. Use the manual locking bars if fitted to the door.

Power Failure

When there is a power failure, the opener will be unable to automatically open or close your garage door. To use your door whilst there is no power you will need to disengage the opener and use the door manually - see Manual Operation.

When the power resumes your opener will be automatically reset. The Code Set and Limit Set LED's will flash for a few seconds whilst the opener undergoes a self-test. The Power LED will then come on, returning your opener to normal operation.

Code Set
Power LED

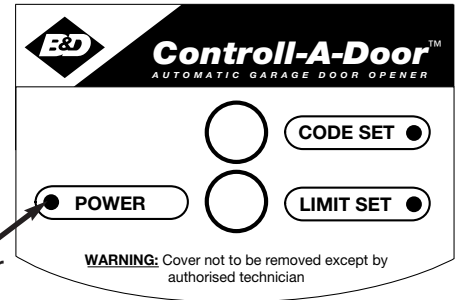

Safety Infra Red Beam Option

A B&D Safety Infra Red Beam Kit (Part No 62153) may be fitted to this opener.

- When this option is fitted and selected, the operation of this device is such that if an object (i.e. car, child, etc) blocks the infra red beam, then the door will not close.
- When the Infra Red dipswitch is activated, the Safety IR Beam accessory must be fitted and functional.
- If the switch is activated and a Safety IR Beam is not fitted or not operating then the door, once opened, cannot be closed. The relays will click twice when attempting to operate the opener to indicate this condition.

Auto Close Option

To have the Auto Close option you must also have a B&D Safety Infra Red Beam (Part No 62153) fitted and functioning. When this option is selected the door will attempt to close automatically 30 seconds after opening. If repeatedly prevented by an obstruction the opener will cease auto closing after the fourth attempt. Once the obstruction is cleared, press the operate button to activate the opener.

Remote Control Transmitter Battery

When necessary, remove the cover and replace the battery. Dispose of the old battery properly.

Changing the Light Globe

Your opener uses a 240 Volt, 25 Watt, standard bayonet Pilot Light globe. If you should need to change a light globe, proceed as follows:

1. Close the garage door to gain better access.
2. Turn off the power at the power point.
3. Remove the light cover.
4. Remove the light globe and replace with a suitable new globe.
5. Refit the light cover.
6. Turn the power on, and
7. Press the operate button to ensure the opener is functioning correctly.

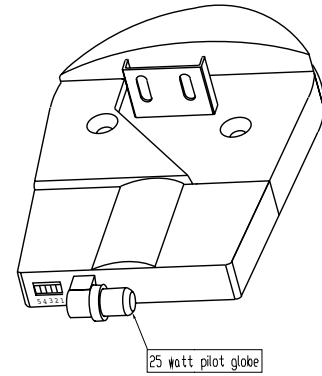

Service Call

If the opener needs service please call the dealer who installed the opener or your local B&D dealer.

Before calling for service you should have the following information to assist in providing the correct service:

1. Has anything happened since the door was last operating OK e.g. storm, a jolt to the door etc?
2. How easy is the door to open/close?
3. What model is the opener?
4. Who installed the opener?
5. When was it installed?
6. Are there any error codes?

Maintenance

Whilst your opener does not require any periodic maintenance, the door that it is fitted to does. To ensure long and trouble free life of your opener the following is recommended:

Monthly

- Disengage the opener and manually operate the door.
- The door must be smooth to operate by hand, and
- Operating force on the bottom rail should not exceed 200 Newtons (20kg) force.
- Each month check that the opener reverses when the door contacts a 40mm high object placed on the floor. Adjust if necessary and recheck since an incorrect adjustment may present a hazard (AS3350). Refer to Step 12.

If the door does not operate smoothly, call B&D or your nearest B&D Authorized Dealer.

Yearly

- We suggest that you contact B&D or your nearest B&D Authorized Dealer to perform an annual door service.



Warning: Failure to maintain your garage door may void your warranty.



Frequently examine the installation, in particular cables, springs and mountings, for signs of wear, damage or imbalance. Do not use if repair or adjustment is needed since a fault in the installation or an incorrectly balanced door may cause injury.

AS3350

Adjustments should only be carried out by experienced persons, as this function can be dangerous if not performed under strict safety procedures.

SECTION 6 – DIAGNOSTIC CODES

The continuous flashing of the Green Power LED on the front panel indicates there may be a problem.

Record the diagnostic code then turn off the power to the opener. After 15 seconds reconnect power to the opener. The Code Set and Limits Set LED's will flash continuously for a few seconds whilst undergoing a self test. This will clear the flashing error code.

Operate the opener – If there is a continuing problem, the type of problem can be identified by checking the red Code Set and Limit Set LEDs. Counting the number of flashes of these LEDs reveals the diagnostic code.

The diagnostic code format is:

Number of Code Set flashes – Number of Limit Set flashes.

i.e. 1 flash of the Code Set LED followed by 2 flashes of the Limit Set LED gives problem code 1-2. This code in the table below shows that either the opener is disengaged or the door is sticking.

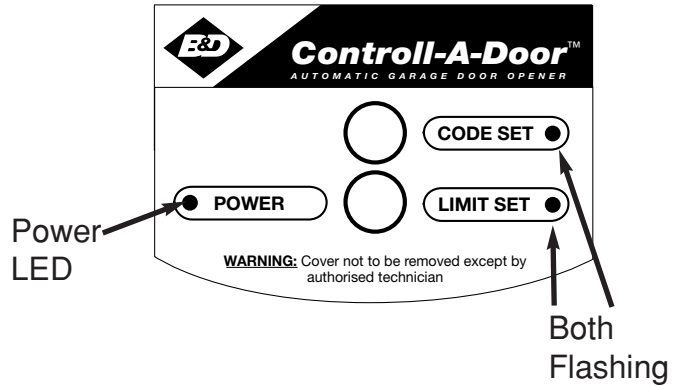

Diagnostic Code	Action
<p>1-1</p> <p>1 flash 1 flash</p>	<p>The opening force setting has been exceeded while the door was opening. With the opener disengaged, check that the door is running freely. If the door operates normally then increase the Opening Force setting.</p>
<p>1-2</p> <p>1 flash 2 flash</p>	<p>The door has not maintained the minimum speed while opening. Check that the opener is engaged. With the opener disengaged check that the door is running freely - the door may need service.</p>
<p>1-3</p> <p>1 flash 3 flash</p>	<p>The motor has run continuously for more than 30 seconds without successfully opening or closing the door. The door you are operating is too high or too stiff for the opener (the door should be serviced and correctly balanced).</p>
<p>1-4</p> <p>1 flash 4 flash</p>	<p>Opto error. The internal position encoder is not working correctly. Possible opto gear failure or PCB encoder dirty (e.g. grease). Contact B&D or an authorized dealer for service.</p>

Diagnostic Code

Action

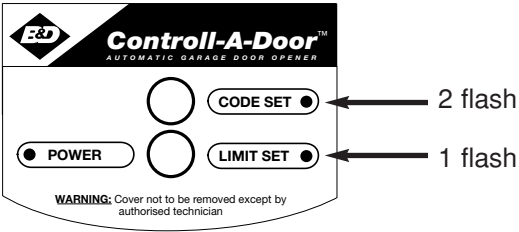
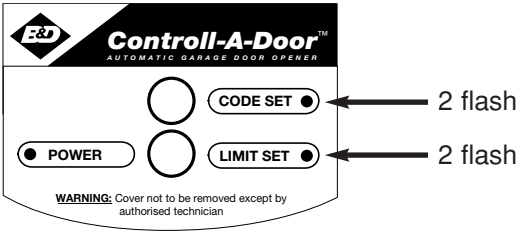
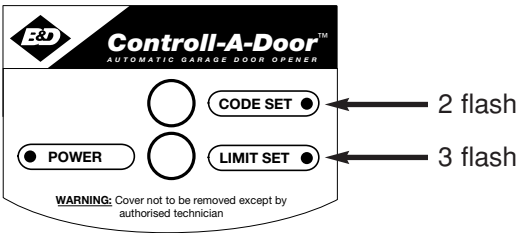
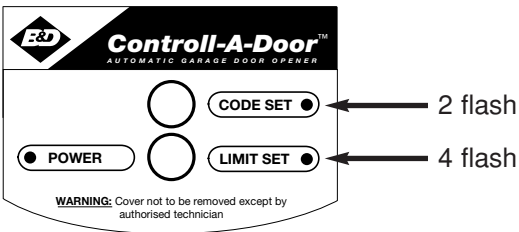
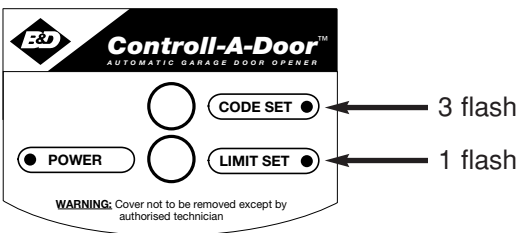
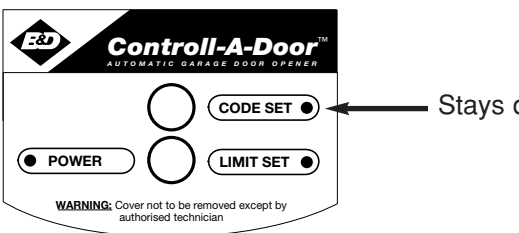
<p>2-1</p>		<p>Check the wiring to the Safety Infra Red Beams. If there are no shorts then the IR Beam detectors may need servicing.</p>
<p>2-2</p>		<p>Either the operate button in the light cover is stuck or an external operate button is shorted. Remove the light cover - check the operate button is not stuck or remove the accessory plug to identify fault.</p>
<p>2-3</p>		<p>Either the Limit Set button is stuck or an external limit set button is shorted. Remove the light cover and remove the accessory plug, if fault remains contact B&D or an authorized dealer for service.</p>
<p>2-4</p>		<p>The Code Set button may be stuck down. Try pressing the button or reset the opener. If problem persists contact B&D or an authorized dealer for service</p>
<p>3-1</p>		<p>An internal electronic fault has occurred. Call B&D or an authorized dealer for service</p>
<p></p>		<p>The Code Set LED will illuminate whenever a 433MHz signal is being transmitted. If the Code Set LED stays on it indicates that there is possibly a 433MHz remote control transmitter with a button stuck on. To identify the faulty remote control transmitter, remove the battery from each transmitter checking the Code Set LED each time. When the battery is removed from the faulty transmitter the Code Set LED will go out.</p>

While the opener is flashing an error code it will not respond to a remote control signal, nor can it learn codes or limits.

The opener can be reset from error mode by either:

- interrupting the mains power,
- by pressing the operate button, or
- by pressing a remote control transmitter that has previously been coded into the opener.

SECTION 7 – TROUBLESHOOTING

Symptom	Probable Cause(s)	Remedy
The opener does not work from either the button on the light cover or the hand remote control transmitter	Garage door in poor condition e.g. springs may be broken	Check the door for normal operation - see monthly maintenance.
	Manual door lock engaged	Disengage door locks
	The opener does not have power	Plug a device e.g. a lamp, into the power point and check that it is OK.
The motor runs but the door does not move	The opener is disengaged	Re-engage the opener
The opener works from the button on the light cover but not from the hand remote control transmitter	The battery in the remote control transmitter is flat	Replace the battery
	The code has not been set	See remote control transmitter & code setting
The remote control transmitter range varies or is restricted	Variations are normal depending on conditions e.g. temperature or external interference	See Instructions for correct use of remote control transmitter
	The battery is flat or faulty	Replace the battery
	Position of the remote control transmitter in the motor vehicle	Change the position - see Instructions for correct use
	Position of the aerial will not pick up the radio signal	Reposition the aerial away from metal mass for maximum range (a short length of wire joined to the existing aerial can be used to good effect)
The light does not work	The globe has blown	Replace the globe
The door reverses for no apparent reason	This may occur occasionally from weather changes, usually during the first year	Check the closing force adjustments (refer to Safety System)
The door opens but will not close	Auto close or safety infra red beam not operating correctly	Check the installation
	Closing force adjuster set too light	Review adjustment (refer to Safety System).

Note: If the door has been moved more than 50mm outside the programmed limits whilst the power is disconnected, the opener will appear as though it has no limits – when the operate button is pressed the Limit Set LED will flash once to indicate an unknown limits condition. To rectify; either move the door back within the programmed limits range or reprogram the door operating limits.

Section 8 – Warranty
Controll-A-Door Automatic Garage Door Opener

1. Definitions

‘B&D’ means

- (a) in Australia - B&D Australia of 34-36 Marigold Street Revesby New South Wales 2212, a division of Kalford Pty Ltd (ABN 25 010 473 971), or
- (b) in New Zealand - B&D Doors NZ Pty Ltd of 70 Allens Road East Tamaki Auckland, which is a subsidiary of Kalford Pty Ltd (an Australian company).

‘Purchaser’ means the purchaser of the Opener.

‘Opener’ means the ‘Controll-A-Door Automatic Garage Door Opener’

‘Authorised Distributor’ means an authorised B&D distributor of the Opener.

‘Major Components’ means all components of the Opener that make up the power head that is attached to a garage door.

‘Ancillary Components’ means all components of the Opener which are not Major Components.

‘Manufacturer’s Written Instruction Manual’ means the instruction manual provided with the Opener.

- 2. This warranty applies to every sale of an Opener to a Purchaser by B&D or its Authorised Distributor, and is the only warranty given on behalf of B&D.
- 3. B&D warrants that it will, at its option, either repair or replace any defects:
 - (i) in materials or workmanship in the Opener, subject to the following:
 - (a) for Major Components of the Opener that are installed by B&D or an Authorised Distributor the warranty shall be valid for a period of sixty (60) months;
 - (b) for Major Components of the Opener that are not installed by B&D or an Authorised Distributor the warranty shall be valid for a period of twelve (12) months, provided that all costs of disconnection, reinstallation and freight shall be borne by the Purchaser.
 - (c) for Ancillary Components of the Opener the warranty shall be valid for a period of twelve (12) months.
 - (ii) in installation for a period of twelve (12) months from the date of installation where the Opener has been installed by B&D or its Authorised Distributor.
- 4. The warranties provided in clause 3(i) shall only apply to an Opener which is being used under normal use and service in accordance with the Manufacturer’s Written Instruction Manual and are limited to the repair or replacement, at B&D’s option, of any defective Opener or parts thereof.
- 5. The warranty provided in clause 3(i) shall apply from:
 - (i) the date of delivery of the Opener by B&D; or
 - (ii) the date of installation of the Opener by B&D or one of its Authorised Installers; or
 - (iii) the date of purchase of the Opener by the Purchaser;whichever is the later.
- 6.
 - (i) Where the Opener has been sold to the Purchaser by B&D, the Purchaser shall make all warranty claims hereunder directly with B&D;
 - (ii) Where the Opener has been sold to the Purchaser by an Authorised Distributor, the Purchaser shall make all warranty claims hereunder directly with the Authorised Distributor.

7. The Purchaser will pay for any service call made by B&D or an Authorised Distributor where such a call is made for the purpose of adjustment (as described in the Manufacturers Written Instruction Manual) and not for rectification of a defect pursuant to the warranty hereunder.
8.
 - (i) The Purchaser shall be responsible for any expense incurred by B&D or an Authorised Distributor in ensuring that the Opener is readily accessible for any repair work carried out under this warranty.
 - (ii) Where an Opener is installed outside a capital city metropolitan area and a warranty claim is made pursuant to this warranty, any travelling expenses and costs of transporting the Opener, incurred by B&D or its Authorised Distributor, shall be borne by the Purchaser.
9. Subject to paragraph 12 hereof;
 - (i) the obligations of B&D under this warranty are limited to those contained herein and such warranties are expressly in lieu of all other warranties, express or implied, including any implied warranty of merchantability or fitness for a particular purpose and notwithstanding any course of dealing between the parties or custom and usage in the trade to the contrary.
 - (ii) B&D shall not be subject to nor incur and the Purchaser releases B&D from any claim or liability (including consequential loss or damage and loss or use or profit) by reason of delay, defective or faulty materials or workmanship, negligence or any act, matter or thing done, admitted or omitted by B&D.
10. Subject to Clause 12 hereof, this warranty does not extend to and B&D will be relieved of all obligations, responsibilities and liabilities (direct or consequential) in the event that defects in manufacture of the Opener are directly or indirectly in the opinion of B&D due to or result from:
 - (i) being fitted to any door or other closing device which is not of the type or condition defined in the Manufacturers Written Instruction Manual as suitable for installation of the Opener.
 - (ii) Lack of proper maintenance or care of the Opener or door.
 - (iii) Incorrect and unreasonable use.
 - (iv) Faulty installation or adjustment of the Opener or door to which the Opener is connected where such installation or adjustment is not carried out by B&D or one of its Authorised B&D Distributors.
 - (v) Failure to observe any instructions or directions provided with the Opener or given to the Purchaser by B&D or an Authorised Distributor.
 - (vi) Modifications or repairs made or attempted to be made by any unauthorised person.
 - (vii) Faulty electrical wiring of structures to which the Opener is affixed.
 - (viii) Radio or other electronic interference (including citizen band transmissions).
 - (ix) Water damage, including effects from rust and corrosion.
 - (x) Use with doors locked.
 - (xi) Operation of the opener with excessively high opening or closing force settings.
11. The warranty contained in Clause 3 does not cover batteries or globes and B&D shall not be liable for any defect, malfunction or failure of such items.
12. It is expressly provided that the warranties or any terms and conditions of them or other statement contained in this document or other literature given to the Purchaser shall not be read or applied so as to purport to exclude, restrict or modify or have the effect of excluding, restricting or modifying the application in relation to the supply of the Opener of all or any of the provisions of Divisions 2 and 2A of Part V of the Trade Practices Act, 1974, or the Consumer Guarantees Act 1993 if the purchase is a 'consumer' and purchased the opener in New Zealand, ("The Act") as amended or the exercise of a right conferred by such a provision or any other condition or warranty implied by any relevant State Act or Territorial Ordinance or by the general law and which by law cannot be excluded, restricted or modified provided that to the extent that the Act permits B&D to limit its liability for a breach of condition or warranty implied by the Act, B&D's liability for such breach shall be limited to the payment of the cost of replacing the Opener or acquiring an equivalent Opener or repairing the Opener.

13. This warranty shall be governed by and construed in accordance with Australian law if the opener was purchased in Australia, or New Zealand law if the opener was purchased in New Zealand
14. Upon making a claim under this warranty the purchaser must produce proof of the date of purchase, together with the details set out below:

<p>Purchased from: _____</p> <p>Installed by: _____</p> <p>Installed on (date): _____</p>
--

The Purchaser shall complete this certificate and keep it together with a copy of the receipt of purchase in a safe place – production of such information will assist the handling of a claim made under this warranty.

NSW Office: B&D Australia, 34-36 Marigold Street, Revesby 2212.
Ph: (02) 9722 5555

QLD Office: B&D Australia, 34-47 Cobalt Street, Carole Park 4300.
Ph: (07) 3271 7000

VIC/TAS Office: B&D Australia, 147-153 Canterbury Road, Kilsyth 3137.
Ph: (03) 9237 7766

SA Office: B&D Australia, 23 Frederick Road, Royal Park 5014.
Ph: (08) 8447 4747

WA Office: B&D Australia, 96 Mulgul Drive, Malaga 6062.
Ph: (08) 9247 8777 Fax: (08) 9247 8700

NZ Office: B&D Doors New Zealand, 70 Allens Road, East Tamaki,
Auckland. Ph: (09) 273 8600 www.bnd.com.nz

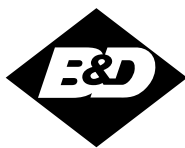

B&D Australia a Division of Kalford Pty Limited
A.B.N. 25 010 473 971
www.bnd.com.au